

**EGLO**  
my light | my style



**2022/23**

**INTERIOR LIGHTING/OUTDOOR LIGHTING**  
LUMINARIAS DE INTERIOR/LUMINARIAS DE EXTERIOR



Estimados clientes, socios comerciales y amigos de Eglo.

Durante el último año, el mundo ha contenido la respiración. Es un año que todos recordarán como uno de distancia y sacrificio, pero también de oportunidad y transformación.

La digitalización en particular ha experimentado enorme crecimiento y siguiendo el lineamiento de nuestro catálogo anterior este año volvemos a presentar su versión en línea.

En nuestro nuevo catálogo 2022/2023 encontrarás aspectos destacados de la iluminación real, con un diseño natural, minimalista y elegante que está de moda, con tonos cálidos y terrosos y elementos de madera y latón que encajarán bien en cualquier hogar. Debido a este diseño natural y la creciente importancia que como sociedad le estamos dando a nuestra conexión con la naturaleza, queríamos comprometernos más intensamente con el tema de sostenibilidad y reconocemos nuestra responsabilidad hacia el medio ambiente. Una de las formas en que hemos logrado esto es a través del cumplimiento de Estándares FSC®, que promueven la responsabilidad global en la gestión de bosques.

Espero que disfrutes hojeando nuestro nuevo catálogo principal.

Dear customers, business partners and trusted EGLO friends.

For the past year, the world has held its breath. It is a year that everyone will remember as one of distance and sacrifice, but also of opportunity and transformation.

Digitalisation in particular has undergone enormous growth and following the guidelines of our previous catalog this year we present the online version again.

In our new catalogue 2022/2023 you will find some real lighting highlights, featuring a natural, minimalist, elegant design that is right on-trend, with warm, earthy tones and elements of wood and brass that will fit well in any home. Because of this natural design and the increased importance we as a society are placing on our connection with nature, we wanted to engage more intensively with the theme of sustainability and recognise our responsibility toward the environment. One of the ways we have achieved this is through compliance with FSC® standards, which promote responsible global forest management.

I hope you enjoy flicking through our new main catalogue.

  
Mag. René Tiefenbacher  
CEO EGLO Group

# CONTENIDOS

## CONTENTS





## **VENTILADORES DE TECHO**

CEILING FANS

P. 9-11

---



## **STARS OF LIGHT**

STARS OF LIGHT

P. 12-89

---



## **FAMILIAS DE LUMINARIAS**

STANDARD LUMINAIRES

P. 90-125

---



## **LUMINARIAS COLGANTES**

HANGING & PENDANT LUMINAIRES

P. 126-147

---



## **COLECCIÓN TREND & STYLE**

TREND & STYLE COLLECTION

P. 148-171

---



## **LUMINARIAS DE PARED Y TECHO**

WALL & CEILING LUMINAIRES

P. 172-189

---



## **SPOTS, RIELES Y EMPOTRADOS**

SPOTS, TRACKS & RECESSED LUMINAIRES

P. 190-197

---



## **LUMINARIAS DE MESA Y PISO**

TABLE & FLOOR LUMINAIRES

P. 198-209

---



## **LUMINARIAS DE BAÑO**

BATH & MIRROR LUMINAIRES

P. 210-233

---



## **LUMINARIAS DE EXTERIOR**

OUTDOOR LUMINAIRES

P. 234-265

---



## **EGLO LIGHT**

EGLO LIGHT

P. 266-287

---



# EGLO TREND HIGHLIGHTS

## 2022/23

El equipo de diseño de EGLO se ha basado una vez más en las megatendencias actuales como fuente de inspiración para la temporada 2022/23. El uso de la forma y el color, la elección de los materiales y la estética general de los nuevos productos EGLO armonizan perfectamente con las tendencias de vida contemporáneas y futuras. El minimalismo y el uso cada vez más popular de materiales y colores como el latón y los tonos tierra han tenido una influencia particularmente fuerte en los diseños de luminarias de esta temporada.

The EGLO design team has once again drawn on current mega-trends as a source of inspiration for the 2022/23 season. The new EGLO products' use of shape and colour, choice of materials, and overall aesthetic harmonise perfectly with both contemporary and future living trends. Minimalism and the increasingly popular use of materials and colours such as brass and earth tones have had a particularly strong influence on this season's luminaire designs.

**MINIMALISMO** - El arte de menos, la reducción consciente de formas y colores a lo esencial, se refleja en nuestras luminarias. Formas claras y sencillas y colores lisos se combinan para crear un ambiente tranquilo, de acuerdo con la máxima "menos es más". Los tonos grises cálidos y los elementos de madera le dan a la habitación un toque acogedor, agregan toques de luz atmosféricos y ofrecen un escenario armonioso para que todo su espacio vital haga su magia sin distracciones.

**MINIMALISM** - The art of less, the conscious reduction of shapes and colours to the bare essentials, is reflected in our luminaires. Clear and simple shapes and plain colours combine to create a calm atmosphere, in keeping with the maxim "less is more". Warm grey tones and timber elements give the room a welcoming touch, adding atmospheric highlights and offering a harmonious stage for your entire living space to work its magic without any distractions.

# MATLOCK





# LAGUNITAS

**BRASS** - El latón, tan popular en los años 50 y 60, disfruta actualmente de una nueva ola de popularidad. Combinados hábilmente con materiales en contraste, los tonos metálicos brillantes del latón aportan un toque de lujo a los espacios habitables sin parecer anticuados. Hemos incorporado el material de alta calidad en nuestros nuevos modelos de luminarias y lo hemos combinado con otros materiales diversos para crear cautivadores diseños modernos que se pueden integrar en una variedad de interiores, desde urbanos hasta clásicos y minimalistas.

**BRASS** - Brass so popular back in the 50s and 60s, is currently enjoying a new wave of popularity. Skilfully paired with contrasting materials, the gleaming metallic hues of brass bring a touch of luxury to living spaces without appearing old-fashioned. We have incorporated the high-quality material into our new luminaire models and combined it with diverse other materials to create captivating modern designs that can be integrated into a variety of interiors, from urban to classical to minimalist.

**TONOS CÁLIDOS DE LA TIERRA** - La muy popular tendencia de volver a la naturaleza también ha provocado un cambio significativo en el campo del diseño. Más y más personas han estado adoptando un regreso a la naturaleza en los últimos años y el uso asociado de materiales naturales también ha dejado su huella en el mundo del color, anunciando el surgimiento del marrón como el nuevo negro. El color marrón en todas sus múltiples facetas se puede combinar maravillosamente con casi cualquier otro color y, gracias a sus diversos tonos tierra, no solo le da a nuestros espacios de vida un toque de naturalidad, sino que también transmite una sensación de calidez y comodidad. La combinación de la tendencia de color popular de este año con elementos de madera y latón ayuda a acentuar su atractivo distintivo.

**WARM EARTH TONES** - The very popular back-to-nature trend has also brought about a significant shift in the field of design. More and more people have been embracing a return to nature in recent years and the associated use of natural materials has also left its mark on the world of colour, heralding the rise of brown as the new black. The colour brown in all its many facets can be beautifully paired with almost any other colour and, thanks to its diverse earthy tones, not only lends our living spaces a touch of naturalness, but also conveys a sense of warmth and comfort. Combining this year's popular colour trend with wood and brass elements helps accentuate its distinctive appeal.



NASTASIA

# ¡Pon atención a este Logo!

## Look out for this Logo!

### ¿Qué es un bosque?

¡Un oasis de paz, los pulmones verdes del mundo y un parque de aventuras para niños de todas las edades!.

El Forest Stewardship Council®(FSC®) es una organización global sin fines de lucro dedicada a la promoción de la gestión forestal responsable en todo el mundo. El FSC® define estándares para el manejo forestal responsable de acuerdo con principios establecidos que son desarrollados y respaldados por partes interesadas de las esferas ambiental, social y económica. Para obtener más información, consulte [www.fsc.org](http://www.fsc.org).

### What is a forest?

A peaceful oasis, the green lungs of the world, and an adventure playground for children of all ages!

The Forest Stewardship Council® (FSC®) is a global, not-for-profit organisation dedicated to the promotion of responsible forest management worldwide. The FSC® defines standards for responsible forest management in accordance with established principles that are developed and supported by stakeholders from the environmental, social and economic spheres. For more information, please see [www.fsc.org](http://www.fsc.org).

¡Busque los productos con certificación FSC®!  
Look out for FSC®-certified products!



The mark of  
responsible forestry



# ceiling **FANS**



# MARINELLA



**35098M**

aluminio, acero, negro mate, acrilico  
aluminium, steel, matt black, plastic



incluido  
included



3x



LED



## Dimensiones/Dimensions

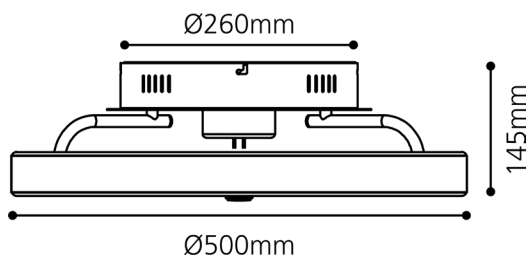

## Flujo de aire/Airflow

Flujo máximo del ventilador (F)	2434 m /h
Potencia del ventilador (P)	35W
Valor de servicio (SV)	1,23 (m /min)W
Velocidad máxima del aire (c)	2,23 metros/sec
Consumo de energía en espera (SV)	0,3W
Nivel de potencia de sonido del ventilador	51,5 dB (A)

## Luz/Light

Watt	40W
Lumen	4200lm
T Kelvin	2700-6500k
Lifetime	25000h
Oscurcimiento continuo	 10-100%



El potente ventilador proporciona una brisa fresca para todas las habitaciones.



INCLUYE CONTROL REMOTO - Controla cómodamente la velocidad del ventilador, las funciones de luz y temporizador.



FUNCIÓN DE TEMPORIZADOR: un cómodo temporizador le permite apagar automáticamente el ventilador después de un período de tiempo predeterminado, por lo que es perfecto para dormitorios.

# PORTSEA



**205653**

acero, negro, plástico, negro  
steel, black, plastic, black

incluido  
included

52" 132cm | ENERGY SAVING DC MOTOR | UV RESISTANT ABS BLADES | 20 WATT LED | TRI COLOUR | STEPLESS DIMMING | REVERSIBLE | REMOTE CONTROL INCLUDED | TIMER | NIGHT MODE Super Low Speed | 5 YEAR WARRANTY

## Dimensiones/Dimensions

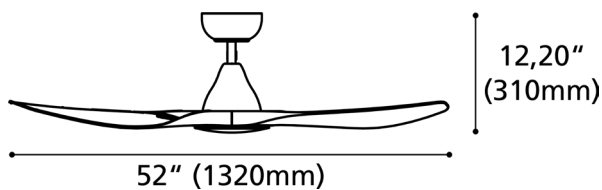

## Ventilador/Fan

Modo nocturno	RPM	Flow Rate (m <sup>3</sup> /Hr)
1	75 RPM	3746m <sup>3</sup> /Hr
2	90 RPM	5038m <sup>3</sup> /Hr
3	125 RPM	7730m <sup>3</sup> /Hr
4	155 RPM	9794m <sup>3</sup> /Hr
5	185 RPM	11323m <sup>3</sup> /Hr
5	205 RPM	13743m <sup>3</sup> /Hr

## Luz/Light

Watt	20W
Voltaje	110-240V~ 50Hz
Lumen	2400lm
T Kelvin	Tri-colour 3000k/4000k/5000k
Lifetime	25000h
Oscurcimiento continuo	10-100%

**DC MOTOR** Equipado con un motor de cc de alta eficiencia energética para proveerle con más velocidades y operación silenciosa, esto mientras se usa hasta el 70% menos energía que los ventiladores de techo AC estándar.

**TRI COLOUR** Incluye una luz LED tricolor integrada, capaz de cambiar entre luz blanca cálida, blanca neutral y blanca fría, desde el conveniente control remoto ¡Su luz, su manera!

**REMOTE CONTROL** Incluye un control remoto EGLO de 6 velocidades permitiéndole controlar el ventilador desde cualquier parte de la habitación. El temporizador incorporado puede apagar el ventilador automáticamente después de un tiempo determinado.

**NIGHT MODE** Los ventiladores de techo EGLO PORTSEA cuentan con un modo nocturno que ralentiza el ventilador a una velocidad súper baja para que el aire circule gentilmente mientras usted duerme, haciéndolo ideal para dormitorios.

# STARS OF LIGHT

## 2022/23

---

Los diseños más finos y fascinantes muestran toda la belleza deslumbrante de la luz. Los materiales preciosos se combinan en diseños impecables: brillantes, resplandecientes, elegantes y sutiles, creando siempre una perfecta armonía con estilo. Las características geniales y emocionantes del diseño industrial de este año tienden hacia formas minimalistas y elegantes para adaptarse a un hogar sostenible en armonía con la naturaleza, mientras que los cristales elegantes y los textiles de alta calidad agregan un brillo resplandeciente y multifacético. El efecto general es un ambiente exclusivo para su espacio vital, garantizado para impresionar en cada ocasión.

---

The finest and most intriguing designs showcase all the stunning beauty of light. Precious materials combine in flawless designs: sparkling, shimmering, elegant and subtle, always creating perfectly stylish harmony. The cool and exciting features of industrial design this year tend towards minimalist, elegant shapes to suit a sustainable home in harmony with nature, while elegant crystals and high-quality textiles add sparkling, multifaceted brilliance. The overall effect is an exclusive ambience for your living space, guaranteed to impress on every occasion.

STARS  
OF  
LIGHT  
2022/23

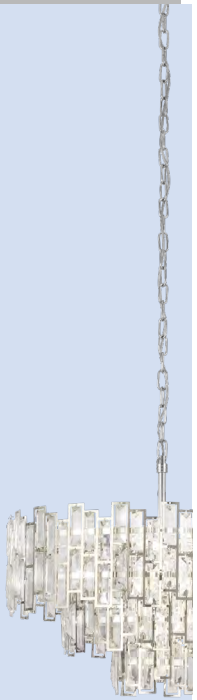

Sparkling  
Crystal  
p. 07

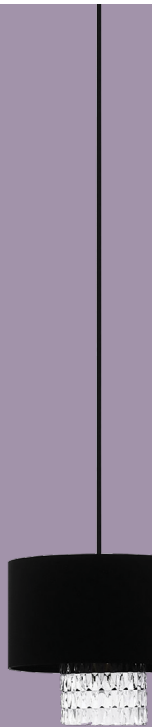

Modern  
Glamour  
p. 07



Timeless  
Reflection  
p. 07



Charming  
Elegance  
p. 07



Clean  
Sophistication  
p. 07

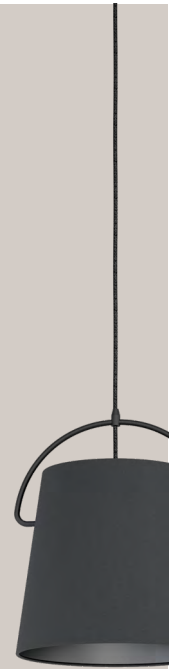

Fabric  
Harmony  
p. 07



Modern  
Industrial  
p. 07

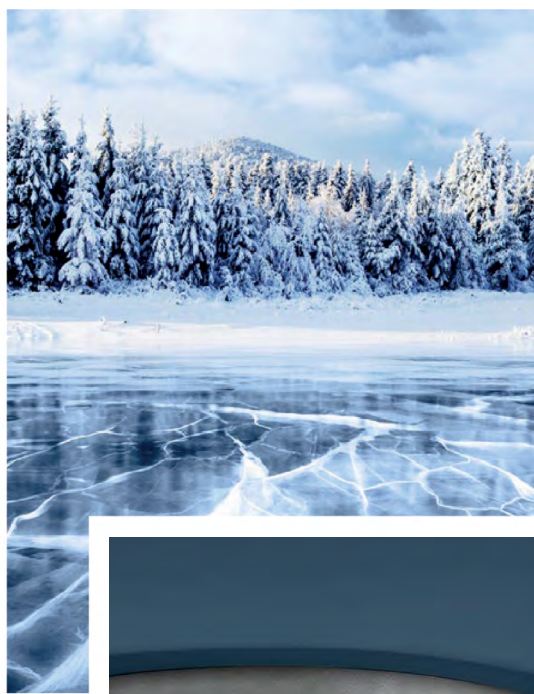

# Sparkling Crystal

*Luminaires with classic elegance, featuring polished surfaces combined with glass or crystals. Their captivating sparkle is sure to impress, showing the beauty of light in all its facets.*



## ◀ 39547M MONTEFIO 2

Luminario colgante de 17 luces; acero, cromo;  
cristal, blanco,  
transparente  
*pendant light; steel, chrome; glass, crystal,  
white, clear*

H 3200, Ø 780

LED

85W

7480 lm

3000k warm white

No dimeable



GL3090 .....

### ◀ 39545M PIANOPOLI 1

Luminario colgante de 40 luces; acero, cromo,  
cristal claro  
*pendant light; steel, chrome; crystal, clear*

H 3340, Ø 780

LED

90 W

10,300 lm

3000k warm white

No dimeable

GL3090 .....

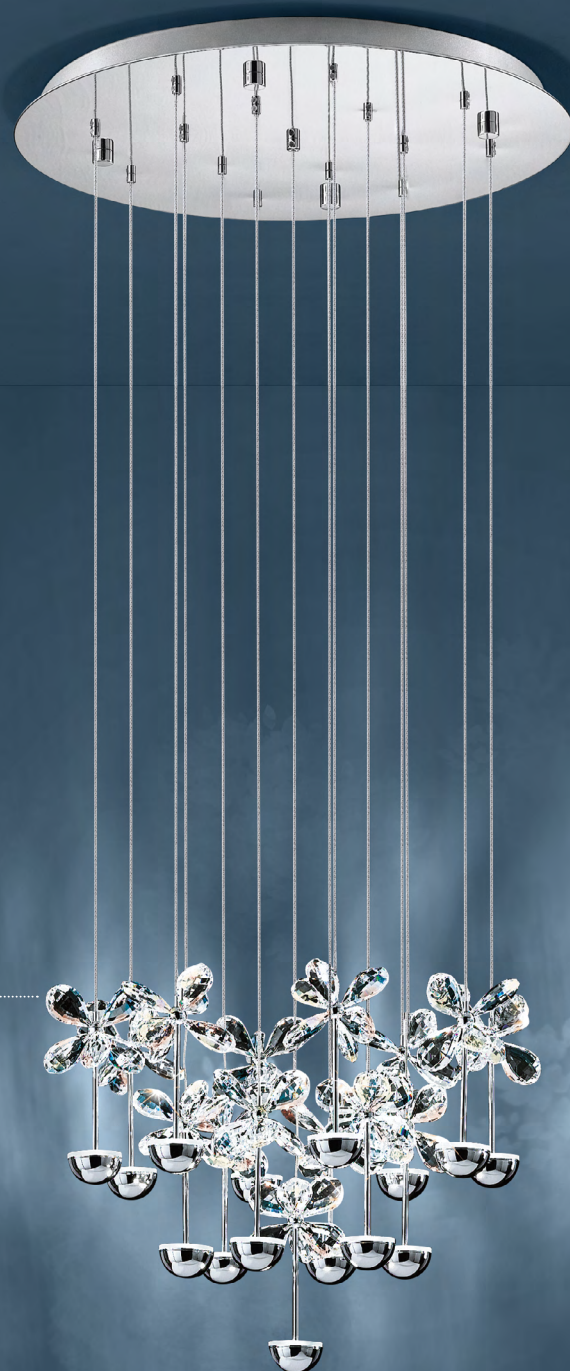

## ▲ 93662M PIANOPOLI

Luminario colgante de 15 luces; cromo, cristal  
*pendant light; stainless steel, chrome; crystal, clear*

H 1100, Ø 500  
LED  
37 W  
3600 lm

3000k warm white  
No dimeable

GL3090 .....



### ▲ 39245A PIANOPOLI

Luminario de techo de 15 luces; cromo, cristal  
ceiling light; stainless steel, chrome; crystal, clear

H 365, Ø 500

LED

31,5 W

3600 lm

3000k warm white

No dimeable

GL3090



### ▲ 39246A PIANOPOLI

Luminario de techo de 43 luces; cromo, cristal  
*ceiling light; stainless steel, chrome; crystal, clear*

H 525, Ø 780  
LED  
90,3 W  
11180 lm

3000k warm white  
No dimeable



## ▲ 93425A CALAONDA

Luminario colgante de 7 luces; cromo, cristal  
*pendant light; stainless steel, chrome; crystal, clear*

H 1830, Ø 500  
G9  
7x 60 W

Incluye lámpara



## ◀ 93423A CALAONDA

Luminario colgante de 1 luz; acero, negro; latón  
*pendant light; stainless steel, chrome; crystal, clear*

L 960, B 230, H 1100  
 G9  
 11x 60 W

Incluye lámpara



## 93424A CALAONDA ▶

Luminario colgante de 7 luces; cromo, cristal  
*pendant light; stainless steel, chrome; crystal, clear*

L 665, B 230, H 1830  
 G9  
 7x 60 W

Incluye lámpara

**93425A, 93423A, 93424A,  
 93413A**

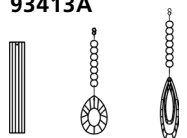

GL3082 GL3033 GL3034  
 GANCHO CRISTAL ET1279



### ▲ 93413A CALAONDA

Luminario de techo de 7 luces; cromo, cristal  
*ceiling light; stainless steel, chrome; crystal, clear*

H 310, Ø 580  
G9  
7x 60 W

Incluye lámpara



GL3032

GL3031

## ▲ 93433A CALAONDA

Luminario de techo de 8 luces; cromo, cristal  
*ceiling light; stainless steel, chrome; crystal, clear*

H 480, Ø 580

G9

8x 60 W

Incluye lámpara

GANCHO CRISTAL ET1279  
GANCHO BASE ET0890



### ◀ 39626 CALMEILLES

Luminario colgante de 10 luces; acero, cromo, cristal, transparente

*pendant light; steel, chrome; crystal, clear*

H 1500, Ø 630

E14

10x 25W

No incluye lámpara

### 39627 CALMEILLES ▶

Luminario colgante de 10 luces; acero, cromo, cristal, transparente

*pendant light; steel, chrome; crystal, clear*

H 1590, Ø 780

E14

10x 25 W

No incluye lámpara





### ◀ 39613 CALMEILLES

Luminario colgante de 10 luces; acero, latón, cristal, transparente

*pendant light; steel, brass, crystal, clear*

H 1500, Ø 630

E14

10x 25W

No incluye lámpara

### 39614 CALMEILLES ▶

Luminario colgante de 10 luces; acero, latón, cristal, transparente

*pendant light; steel, brass, crystal, clear*

H 1590, Ø 780

E14

10x 25 W

No incluye lámpara





GF00045701

### ▲ 39462 VALPARAISO

Luminario colgante de 10 luces; acero, dorado, cristal,  
transparente  
*pendant light; steel, gold-coloured, crystal, clear*

L 900, B 300, H 1100

E14

10x 40 W

No incluye lámpara



..... GF00045701

### ▲ 39463 VALPARAISO

Luminario colgante de 10 luces; acero, dorado, cristal,  
transparente  
*pendant light; steel, gold-coloured, crystal, clear*

L 1150, B 300, H 1100  
E14  
13x 40 W

No incluye lámpara



# Modern Glamour

*Elegantly shimmering crystals set into luminaires in a contemporary design reflect the light to create a special focal point for any home.*

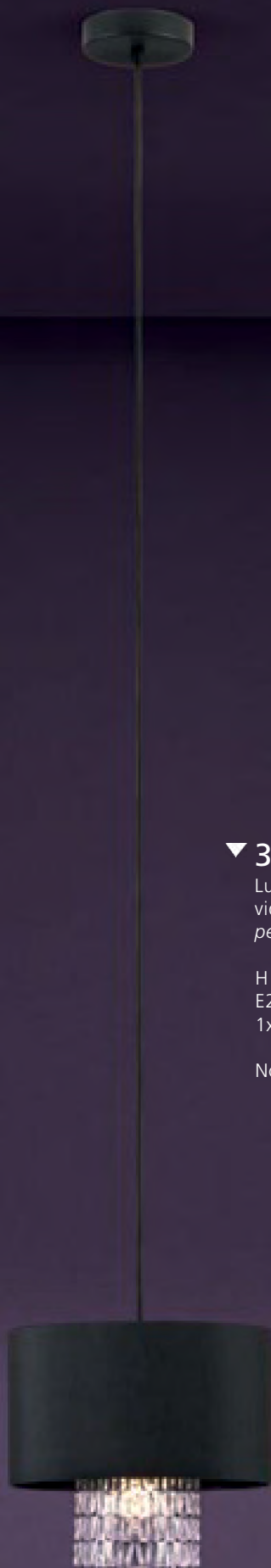

### ▼ 39977 SAPUARA

Luminario colgante de 1 luz, acero, textil, negro, vidrio transparente  
*pendant light; steel, black; fabric, glass, black, clear*

H 1500, Ø 240

E27

1x 40 W

No incluye lámpara



### ▲ 39978 SAPUARA

Luminario colgante de 3 luces, acero, textil, negro, vidrio transparente  
*pendant light; steel, black; fabric, glass, black, clear*

L 1240, B 240, H 1500  
E27  
3x 40 W

No incluye lámpara



## ▲ 204356A ANTELAO

Luminario colgante LED: acero, negro, cristal, claro  
*pendant light; steel, black, crystal, clear*

H 2050, Ø 610  
LED  
32 W  
3700 lm

3000k warm white  
No dimeable



▲ 204357A ANTELAO

Luminario colgante LED: acero, negro, cristal, claro  
*pendant light; steel, black, crystal, clear*

L 1150, B 320, H 2050  
LED  
43 W  
4200 lm

3000k warm white  
No dimeable



## ▲ 204358A ANTELAO

Luminario colgante LED: acero, negro, cristal, claro  
*pendant light; steel, black, crystal, clear*

L 1150, B 320, H 2050  
LED  
30 W  
3500 lm

3000k warm white  
No dimeable

## 204986M CABEZOLA ▶

Luminario colgante de 1 luz; acero, níquel; cristal claro  
*pendant light; steel, nickel-nero; glass, crystal, clear*

H 1100, Ø 120  
LED  
1x 5,3 W  
580 lm

3000k warm white  
No dimeable

GE000267W0





## ▲ 204987M CABEZOLA

Luminario colgante de 4 luces; acero, níquel; cristal claro  
*pendant light; steel, nickel-nero; glass, crystal, clear*

L 1050, B 120, H 1100

LED

4x 6,6 W

2880 lm

3000k warm white

No dimeable

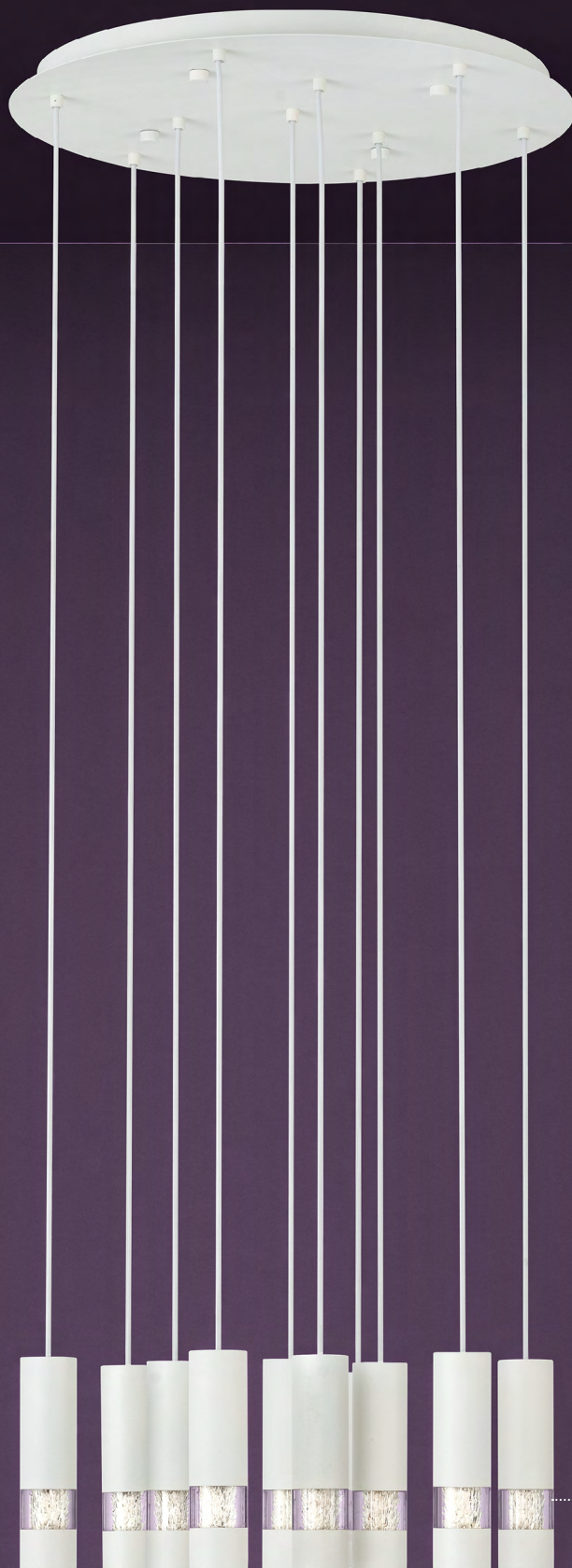

## ◀ 205002M BERNABETA

Luminario colgante de 10 luces; acero, blanco,  
plástico transparente  
*pendant light; steel, white ; plastic,  
transparent*

H 1500, Ø 580  
GU10  
10x 5 W  
10x 400 lm

3000k warm white  
incluye lámpara

.....PB03047901



## ◀ 205003M BERNABETA

Luminario colgante de 10 luces; acero, negro,  
plástico transparente  
*pendant light; steel, black; plastic, transparent*

H 1500, Ø 580  
GU10  
10x 5 W  
10x 400 lm

3000k warm white  
Incluye lámpara

.....PB03047901



# Timeless Reflection

*These timeless luminaires captivate with their straight lines and clean design, showcasing glass and light in their own unique way.*



▲ **390066 DUGLIA**

Luminario colgante de 1 luz; acero, negro; latón, vidrio vaporizado, negro-transparente  
*pendant light; steel, black; steel, glass vaporized, brushed brass, black-transparent*

H 1500, Ø 280  
E27  
1x 40 W



▲ **390067 DUGLIA**

Luminario colgante de 3 luces; acero, negro; latón, vidrio vaporizado,  
negro-transparente  
*pendant light; steel, black; steel, glass vaporized, brushed brass, black-trans-  
parent*

L 1280, B 280, H 1500  
E27  
3x 40 W



▼ **390089 CORDOBA**

Luminario colgante de 1 luz; acero, negro; vidrio vaporizado, cobre  
*pendant light; steel, black; glass vaporized, copper-coloured*

H 1500, Ø 300  
E27  
1x 40 W



### ▲ 390091 CORDOBA

Luminario colgante de 3 luces; acero, negro; vidrio vaporizado, cobre  
*pendant light; steel, black; glass vaporized, copper-coloured*

L 1100, B 250, H 1500  
E27  
3x 40 W



### ◀ 39671M BULCIAGO

Luminario colgante de 1 luz; acero, negro, latón; vidrio vaporizado, ámbar  
*pendant light; steel, black, brass; glass vaporized, amber*

H 1500, Ø 250  
E26  
1x 40 W

No incluye lámpara

GA00048202

### 39672M BULCIAGO ▶

Luminario colgante de 1 luz; acero, negro, latón; vidrio vaporizado, ámbar  
*pendant light; steel, black, brass; glass vaporized, amber*

H 1500, Ø 350  
E26  
1x 40 W

No incluye lámpara



GA00048302

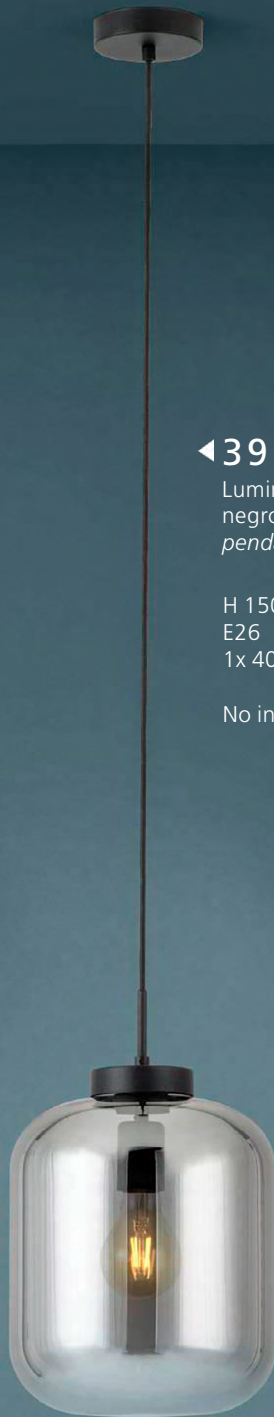

## ◀ 39673M BULCIAGO

Luminario colgante de 1 luz; acero, negro; vidrio vaporizado,  
negro-transparente  
*pendant light; steel, black; glass vaporized, black-transparent*

H 1500, Ø 250

E26

1x 40 W

No incluye lámpara

GA00048203



◀ **39674M BULCIAGO**

Luminario colgante de 1 luz; acero, negro; vidrio vaporizado,  
negro-transparente  
*pendant light; steel, black; glass vaporized, black-transparent*

H 1500, Ø 350

E26

1x 40 W

No incluye lámpara

.....GA00048303



### ◀ 39668M ALBARINO

Luminario colgante de 5 luces; acero, vidrio,  
negro vaporizado  
*pendant light; steel, chrome; glass vaporized,  
black-transparent*

H 1500, Ø 555  
E26  
5x 40 W

No incluye lámpara

### 39665A ALBARINO ▶

Luminario colgante de 1 luz; acero, vidrio,  
negro vaporizado  
*pendant light; steel, chrome; glass vaporized,*

H 1500, Ø 350  
E26  
40 W

No incluye lámpara





### ▲ 39504M SIRACUSA

Luminario colgante de 4 luces; acero, cromo; vidrio ahumado, negro-transparente  
*pendant light; steel, chrome; smoked glass, black-transparent*

L 1130, B 125, H 1100  
E26  
4x 60 W



### ◀ 39537 POLVERARA

Luminario colgante de 1 luz; acero, negro; vidrio vaporizado, ámbar  
*pendant light; steel, black; glass vaporized, amber*

H 1500, Ø 180

E27

1x 40 W

No incluye lámpara



### 39538 POLVERARA ▶

Luminario colgante de 2 luces; acero, negro; vidrio vaporizado, ámbar  
*pendant light; steel, black; glass vaporized, amber*

L 750, B 180, H 1500

E27

2x 40 W

No incluye lámpara



GE00025101

### ▲ 39539 POLVERARA

Luminario colgante de 3 luces; acero, negro; vidrio vaporizado, ámbar  
*pendant light; steel, black; glass vaporized, amber*

L 1150, B 180, H 1500  
E27  
3x 40 W

No incluye lámpara

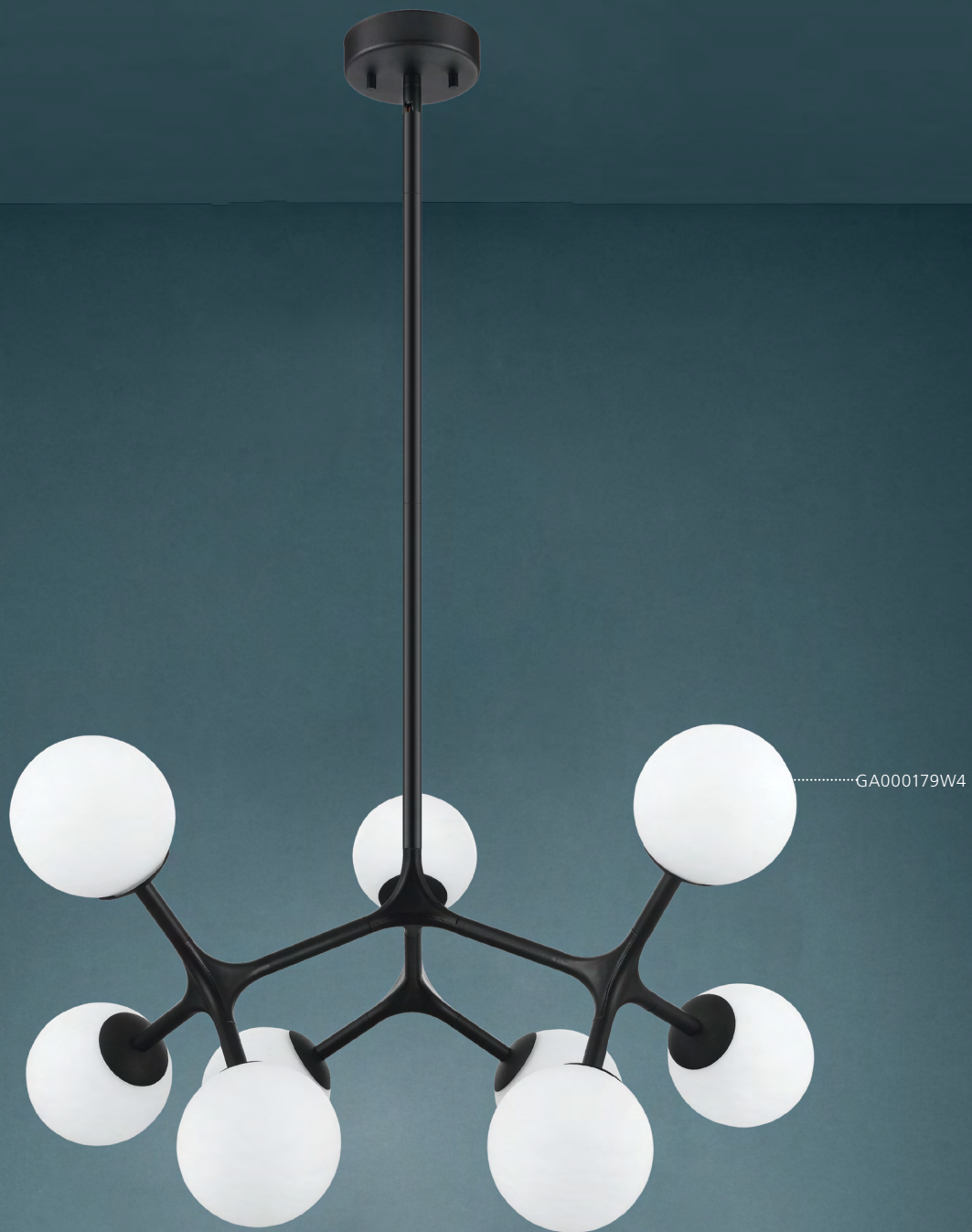

## ▲ 204031A MARAGALL

Luminario colgante de 9 luces; acero, negro; vidrio opal-mate, blanco  
*pendant light; steel, black; glass opal-matt, white*

H 1757, Ø 740  
G9  
9x 3 W

No incluye lámpara



## ▲ 205001M MARAGALL

Luminario de techo de 9 luces; acero, negro; vidrio opal-mate, blanco  
*ceiling light; steel, black; glass opal-matt, white*

H 420, Ø 735

G9

9x 3 W

No incluye lámpara



## ▲ 204999M MARAGALL

Luminario de techo de 12 luces; acero, negro; vidrio opal-mate, blanco  
*ceiling light; steel, black; glass opal-matt, white*

L 1005, B 905, H 380

G9

12x 3 W

No incluye lámpara



### ▲ 39592A SALVEZINAS

Luminario colgante de 2 luces; acero, negro; vidrio opal-mate, blanco  
*pendant light; steel, black; glass opal-matt, white*

L 825, B 520, H 1100  
E26  
2x 60 W

No incluye lámpara

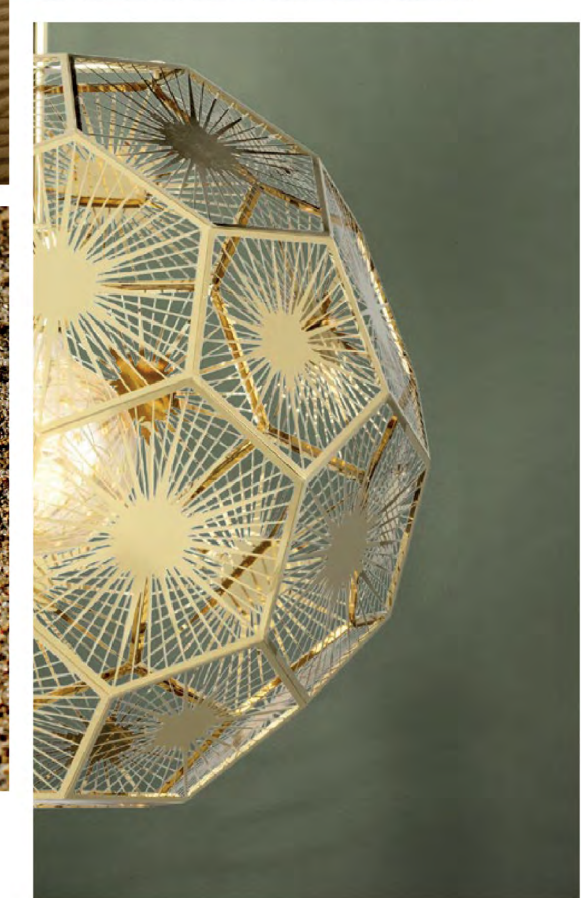

# Charming Elegance

*These modern luminaires, with black surfaces combined with warm colours and featuring refined details, create an elegant ambiance.*



### ▲ 390037 JAZMINIA

Luminario colgante de 1 luz; acero, negro, latón, vidrio transparente  
*pendant light; steel, black, brass, glass, clear*

H 1500, Ø 195  
E27  
1x 40 W

No incluye lámpara



### ▲ 39918 SINSIGA

Luminario colgante de 1 luz; acero, negro; tela, película, vidrio, negro, oro, negro-transparente  
*pendant light; steel, black; fabric, film, glass, black, gold, black-transparent*

H 1500, Ø 170  
E27  
1x 40 W

No incluye lámpara



### ▲ 39921 SINSIGA

Luminario colgante de 6 luces; acero, negro; tela, película, vidrio, negro, oro, negro-transparente  
*pendant light; steel, black; fabric, film, glass, black, gold, black-transparent*

L 1395, B 270, H 1500  
E27  
6x 40 W

No incluye lámpara



### ▼ 39952A ARENALES

Luminario colgante de 1 luz; acero, latón cepillado; vidrio opalino mate, blanco

*pendant light; steel, brushed brass; glass opal-matt, white*

H 1500, Ø 180

E27

1x 60 W

No incluye lámpara



▲ **39953A ARENALES**

Luminario colgante de 3 luces; acero, latón cepillado; vidrio opalino mate, blanco

*pendant light; steel, brushed brass; glass opal-matt, white*

L 1100, B 275, H 1500

E27

3x 60 W

No incluye lámpara

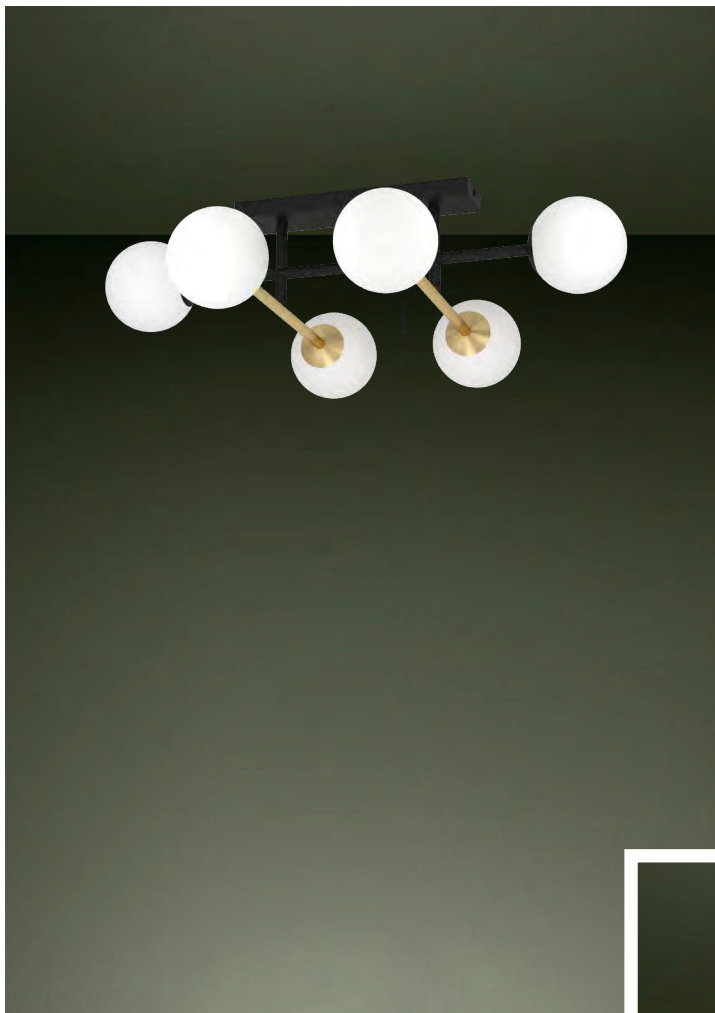

### ◀ 390176 PAZ

Luminario de techo de 6 luces; acero, negro, latón cepillado;  
vidrio opalino mate, blanco  
*ceiling light; steel, black, brushed brass; glass opal-matt, white*

L 775, B 495, H 225

E14

6x 40 W

No incluye lámpara

### 390177 PAZ ▶

Luminario colgante de 3 luces; acero, negro, latón cepillado;  
vidrio opalino mate, blanco  
*ceiling light; steel, black, brushed brass; glass opal-matt, white*

L 635, B 195, H 1500

E14

3x 40 W

No incluye lámpara

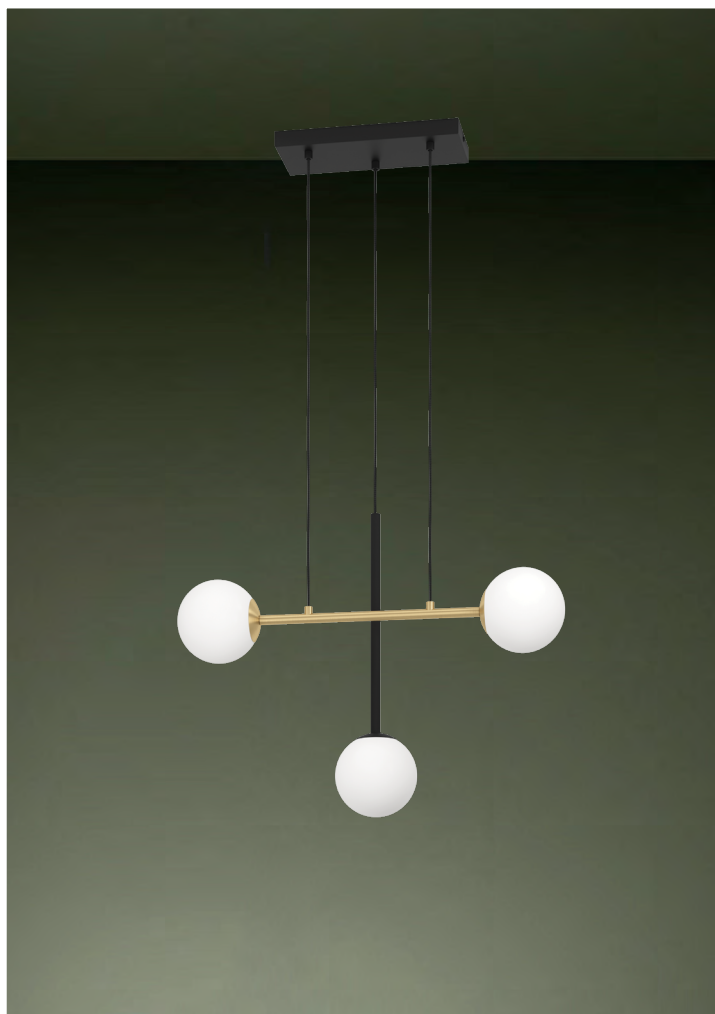

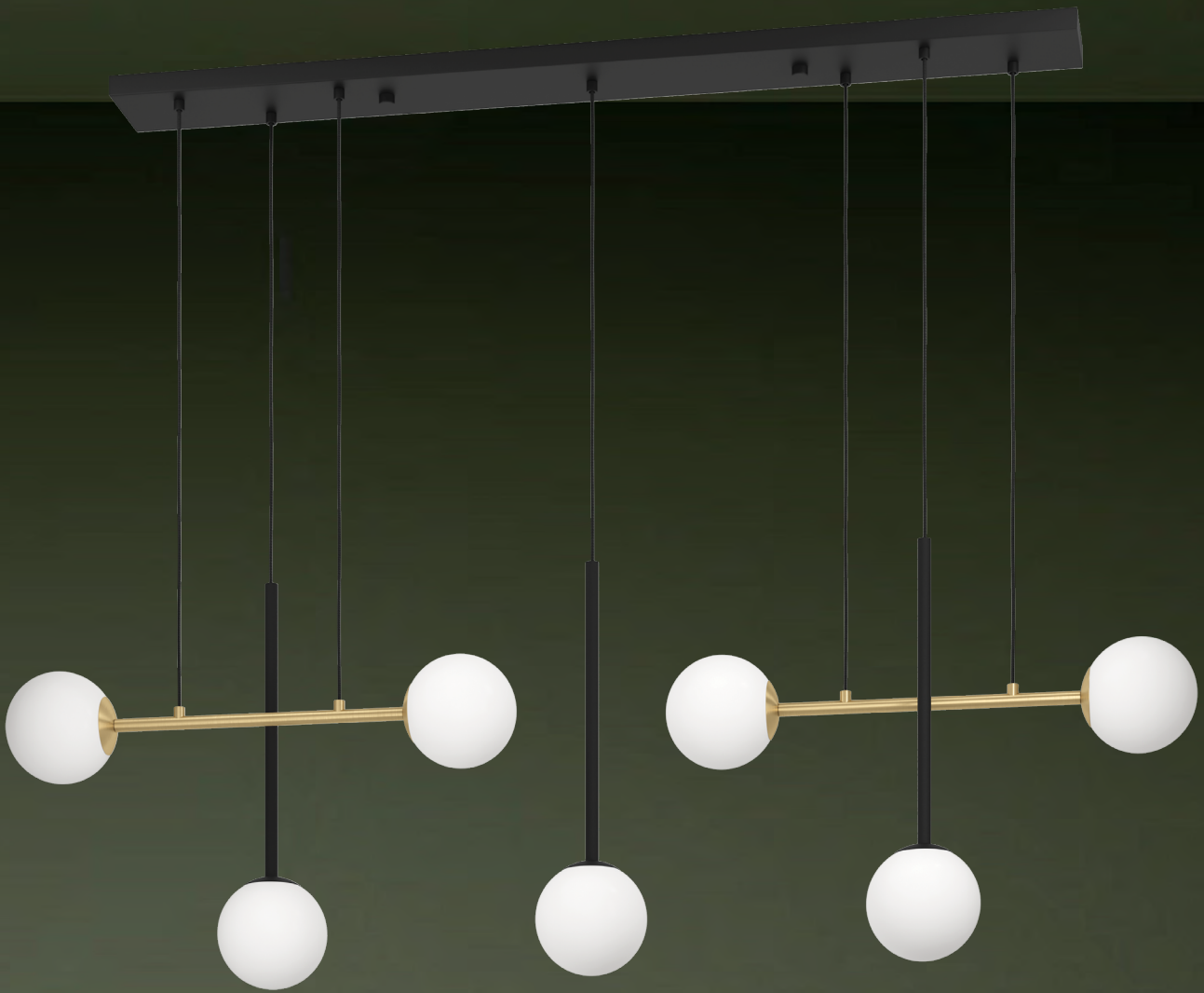

### ▲ 390178 PAZ

Luminario de techo de 7 luces; acero, negro, latón cepillado;  
vidrio opalino mate, blanco  
*ceiling light; steel, black, brushed brass; glass opal-matt, white*

L 1445, B 195, H 1500  
E14  
7x 40 W

No incluye lámpara



## ▲ 205643A ALTAMIRA

Luminario colgante de 1 luz; acero, negro, níquel satinado, plástico blanco  
*pendant light; steel, black, satinated nickel, plastic, white*

H 1964, L 1154  
GU10 LED  
4x 5,3 W

No incluye lámpara



### ◀ 39754 SKOURA

Luminario colgante de 1 luz; acero, negro; latón  
*pendant light; steel, black, brass*

H 1500, Ø 300  
E27  
1x 60 W

No incluye lámpara

### 39755 SKOURA ▶

Luminario colgante de 1 luz; acero, negro; latón  
*pendant light; steel, black, brass*

H 1500, Ø 410  
E27  
1x 60 W

No incluye lámpara





### ◀ 39756 SKOURA

Luminario colgante de 1 luz; acero, negro; latón  
*pendant light; steel, black, brass*

H 1500, Ø 500  
E27  
1x 60 W

No incluye lámpara

MZ10066107

### 39757 SKOURA ▶

Luminario colgante de 3 luces; acero, negro; latón  
*pendant light; steel, black, brass*

L 1300, B 255, H 1500  
E27  
3x 60 W

No incluye lámpara



## ◀ 39758 SKOURA

Luminario colgante de 3 luces; acero, negro; latón  
*pendant light; steel, black, brass*

L 700, B 675, H 1500

E27

3x 60 W

No incluye lámpara

MZ10065907

MZ10066107

MZ10066007



▼ **39619 SKOURA**

Luminario colgante de 1 luz; acero, negro  
*pendant light; steel, black*

H 1500, Ø 500

E27

1x 60 W

No incluye lámpara



▼ **205637A SKOURA**

Luminario colgante de 1 luz; acero, cromo  
*pendant light; steel, chrome*

H 1720, Ø 300

E26

1x 60 W

No incluye lámpara



## ▲ 39634 RASIGURES

Luminario colgante de 3 luces; acero, negro, oro  
*pendant light; steel, black, gold*

L 780, B 180, H 1100  
E27  
3x 28 W

No incluye lámpara



## 39635 RASIGURES ▶

Luminario colgante de 5 luces; acero, negro, oro  
*pendant light; steel, black, gold*

H 1500, Ø 570

E27

5x 28 W

No incluye lámpara

.....MZ100615R1-IG

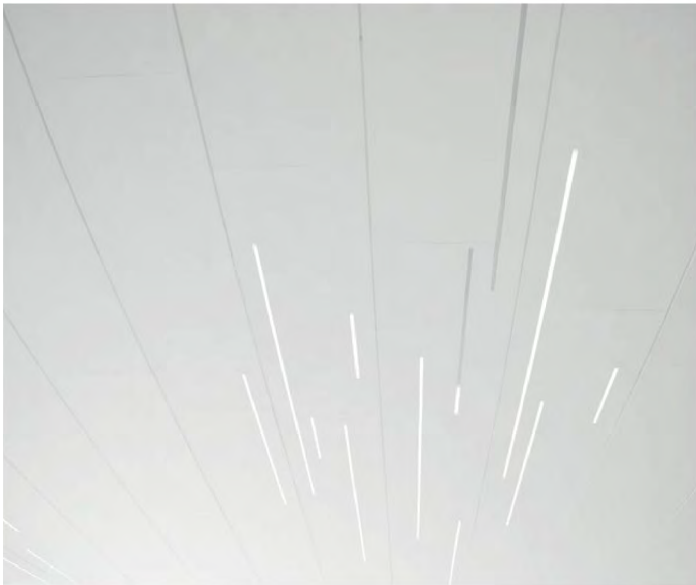

# Clean Sophistication

*These sophisticated luminaires are right on trend thanks to their timeless, minimalist design, and place the emphasis on functional lighting.*



## ▲ 205646A LINDOZA

Luminario colgante de 4 luces; acero, negro; plástico, blanco, negro  
*pendant light; steel, black; plastic, white, black*

H 1896, L 1287, B 411  
LED 4x 8.4W  
4000 lm  
3000k warm white  
Dimeable, dimmer no incluido

LED integrado



### ▲ 39915A LINDOZA

Luminario colgante de 6 luces; acero, negro; plástico, blanco  
*pendant light; steel, black; plastic, white*

H 1896, L 1287, B 411  
LED 6 x 8.4W  
6000 lm  
3000k warm white  
Dimeable, dimmer no incluido

LED integrado





OC00002401

### ▲ 39822M MENTALONA

Luminario colgante de 4 luces; acero, antracita; terrazo, negro, blanco  
*pendant light; steel, anthracite; terrazzo, black, white*

L 840, B 65, H 1500  
GU10  
4 x 3 W  
Incluye lámpara



## 205004M MENTALONA ▶

Luminario colgante de 5 luces; acero, antracita; terrazo,  
negro, blanco

*pendant light; steel, anthracite; terrazzo, black, white*

H 1500, Ø 365

GU10

5x 3 W

incluye lámpara

OC00002401

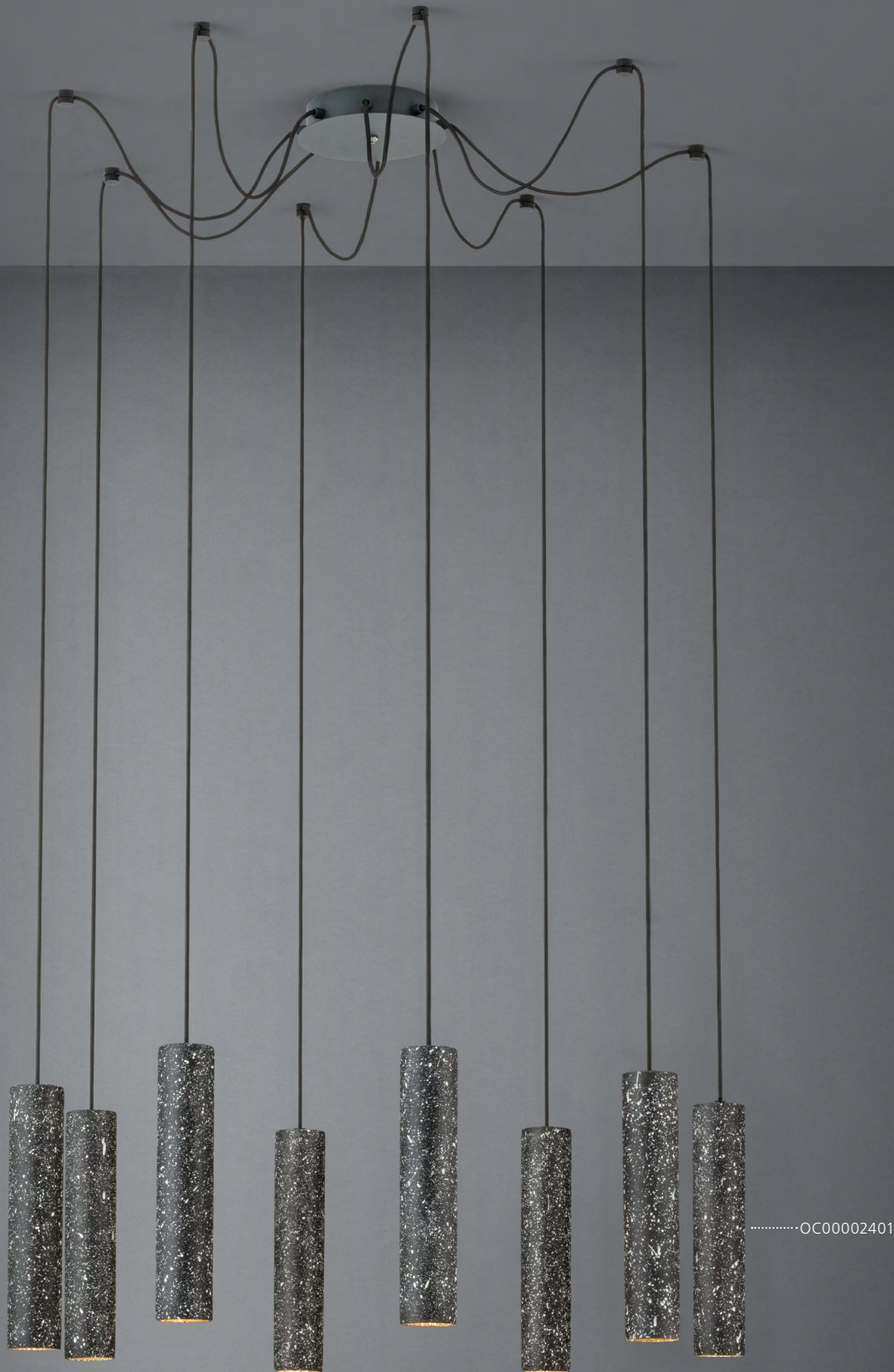

OC00002401

## ▲ 205005M MENTALONA

Luminario colgante de 8 luces; acero, antracita; terrazo, negro, blanco  
*pendant light; steel, anthracite; terrazzo, black, white*

H 1500, Ø 185  
GU10  
8x 3 W

Incluye lámpara

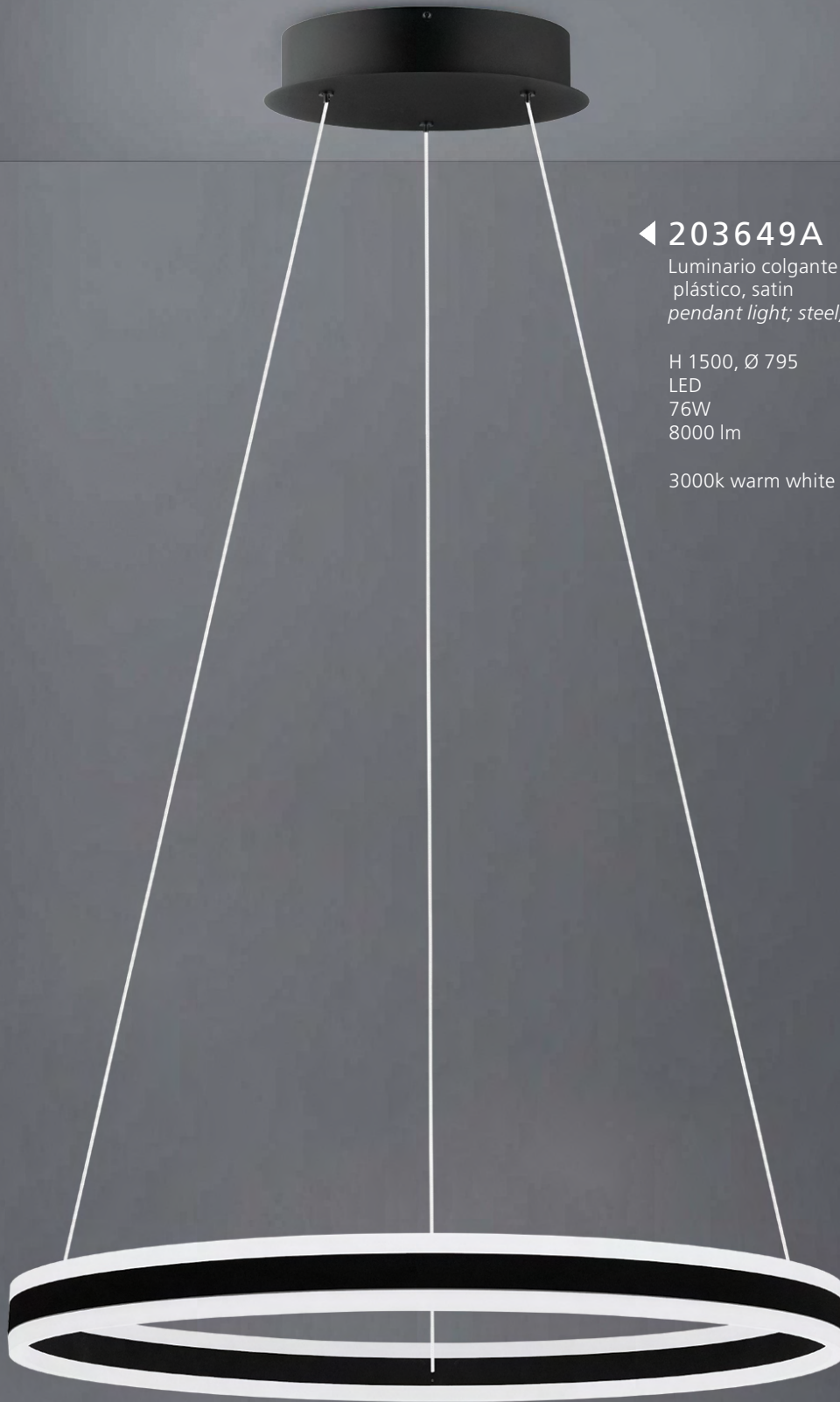

## ◀ 203649A TONARELLA

Luminario colgante de 1 luz; acero, negro,  
plástico, satin  
*pendant light; steel, black, plastic, satined*

H 1500, Ø 795

LED

76W

8000 lm

3000k warm white

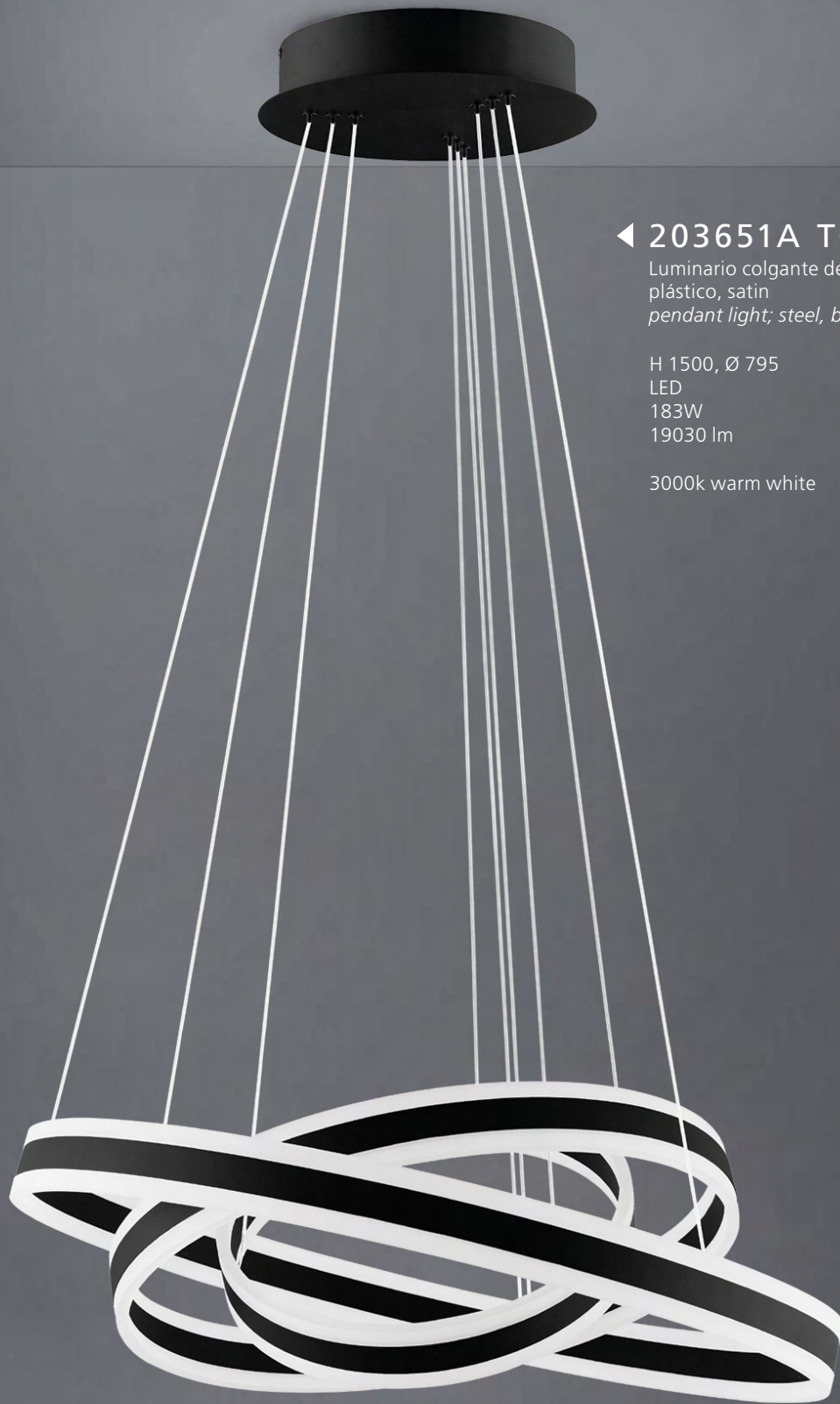

◀ **203651A TONARELLA**

Luminario colgante de 3 luces; acero, negro,  
plástico, satin  
*pendant light; steel, black, plastic, satined*

H 1500, Ø 795

LED

183W

19030 lm

3000k warm white

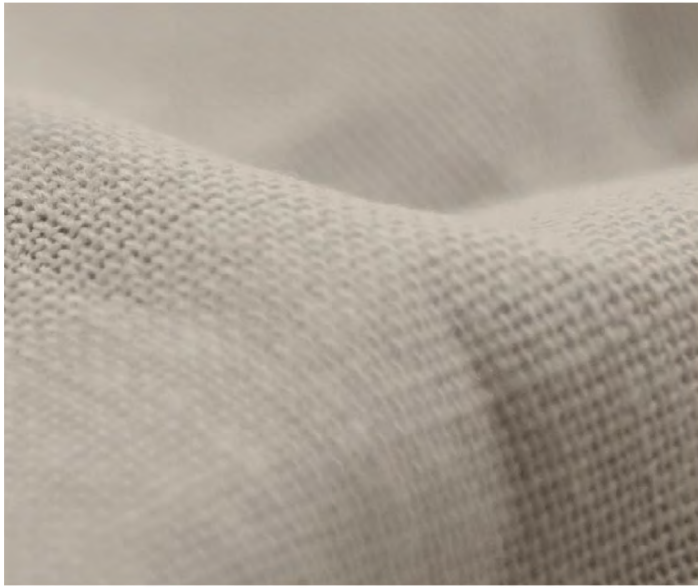
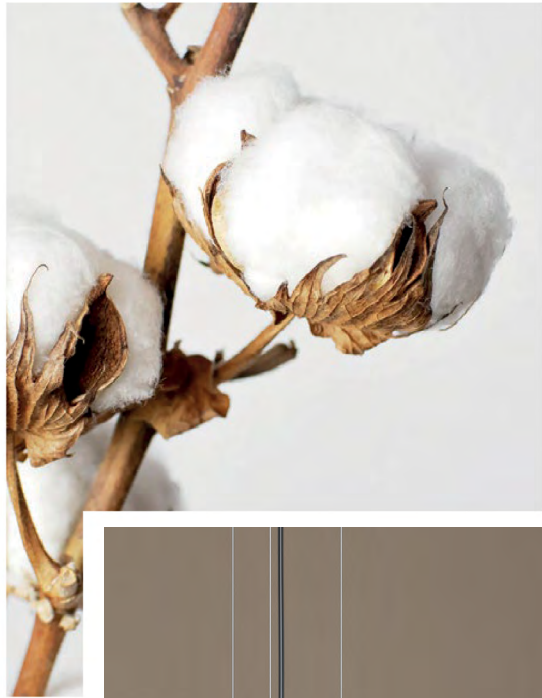

# Fabric Harmony

*These sophisticated luminaires are right on trend thanks to their timeless, minimalist design, and place the emphasis on functional lighting.*



.....OA02072001

### ▲ 39865 GRANADILLOS

Luminario colgante de 1 luz; acero, negro; tela, negro  
*pendant light; steel, black; fabric, black*

H 1100, Ø 280

E27

1x 40 W

No incluye lámpara



## ◀ 39866A GRANADILLOS

Luminario de Mesa de 1 luz; acero, negro; tela, negro  
*table light; steel, black; fabric, black*

L 450, B 220, H 640, Base: Ø 200

E26

1x 40 W

No incluye lámpara



## 39867A GRANADILLOS ▶

Luminario de Pie de 1 luz; acero, negro; tela, negro  
*floor light; steel, black; fabric, black*

L 860, B 280, H 1455, Base: Ø 250

E26

1x 40 W

No incluye lámpara



### ▲ 99274 ESTEPERRA

Luminario colgante de 1 luz; acero, negro; tela, negro, dorado  
*pendant light; steel, black; fabric, black, gold*

H 1100, Ø 530

E27

3x 40 W

No incluye lámpara



## ◀ 39845 ESCUELA

Luminario colgante de 1 luz; acero, negro; tela, vidrio, negro, transparente  
*pendant light; steel, black; fabric, glass, black, clear*

H 1500, Ø 530

E27

3x 16 W

No incluye lámpara

..... OA02072201



◀ **39882 TORTOLA**

Luminario colgante de 3 luces; acero, negro; tela, blanco  
*pendant light; steel, black; fabric, white*

H 1100, Ø 450  
E27  
3x 40 W

No incluye lámpara

.....OA02069901

OA02071502

### ▲ 39764 TAMARESCO

Luminario colgante de 2 luces; acero, latón cepillado; terciopelo, blanco, orendant light; steel, brushed brass; velvet, white, gold

L 1020, B 300, H 1500  
E27  
2x 40 W

No incluye lámpara

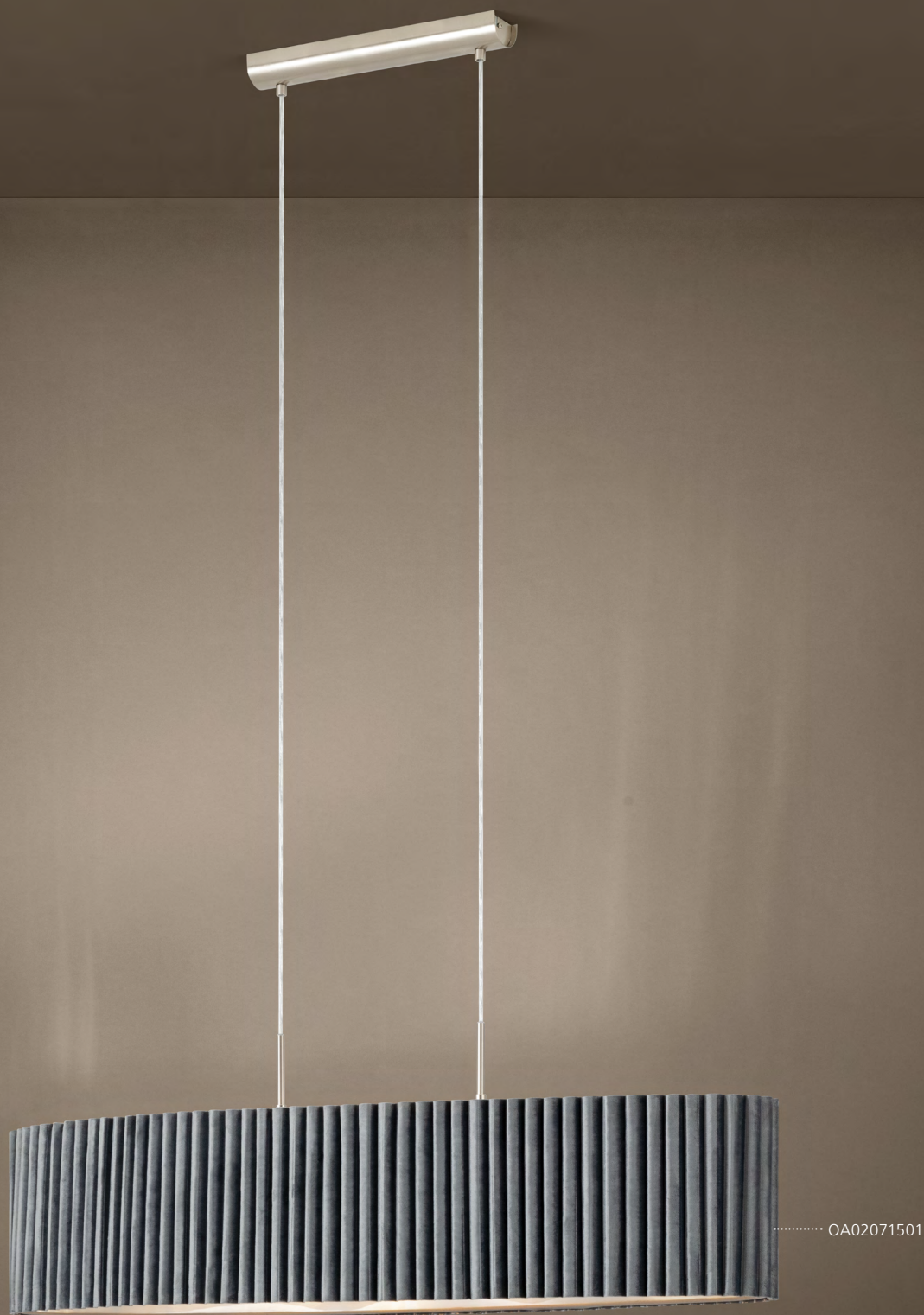

..... OA02071501

### ▲ 39773 TAMARESCO

Luminario colgante de 2 luces; acero, níquel satinado; terciopelo, gris  
*pendant light; steel, satin nickel; velvet, grey*

L 1020, B 300, H 1500  
E27  
2x 40 W

No incluye lámpara

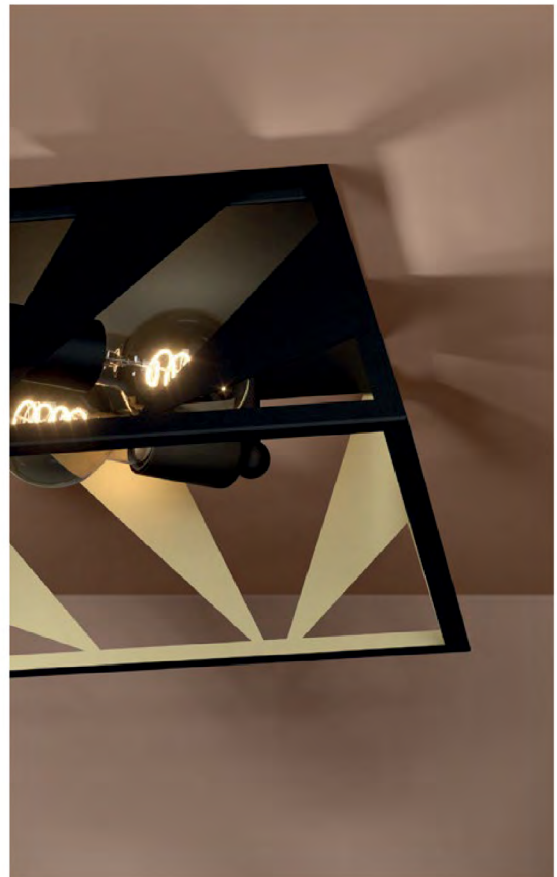
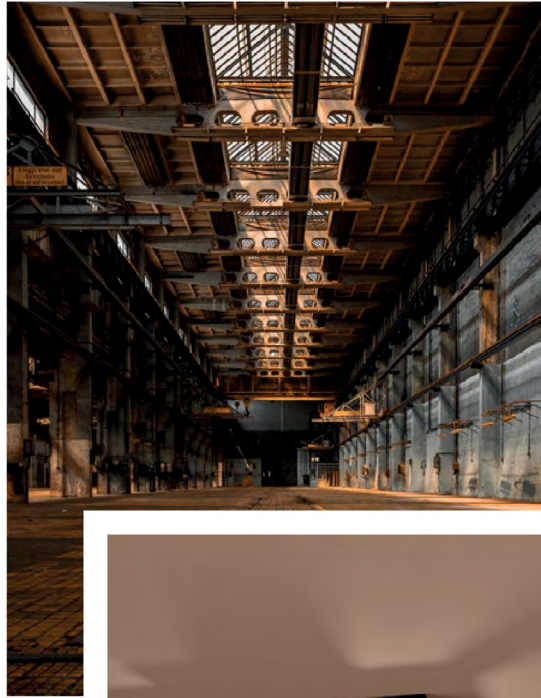

# Modern Industrial

*These luminaires in the exciting new industrial look feature an impressive combination of cool materials and intriguing designs, lending a unique flair to every room.*

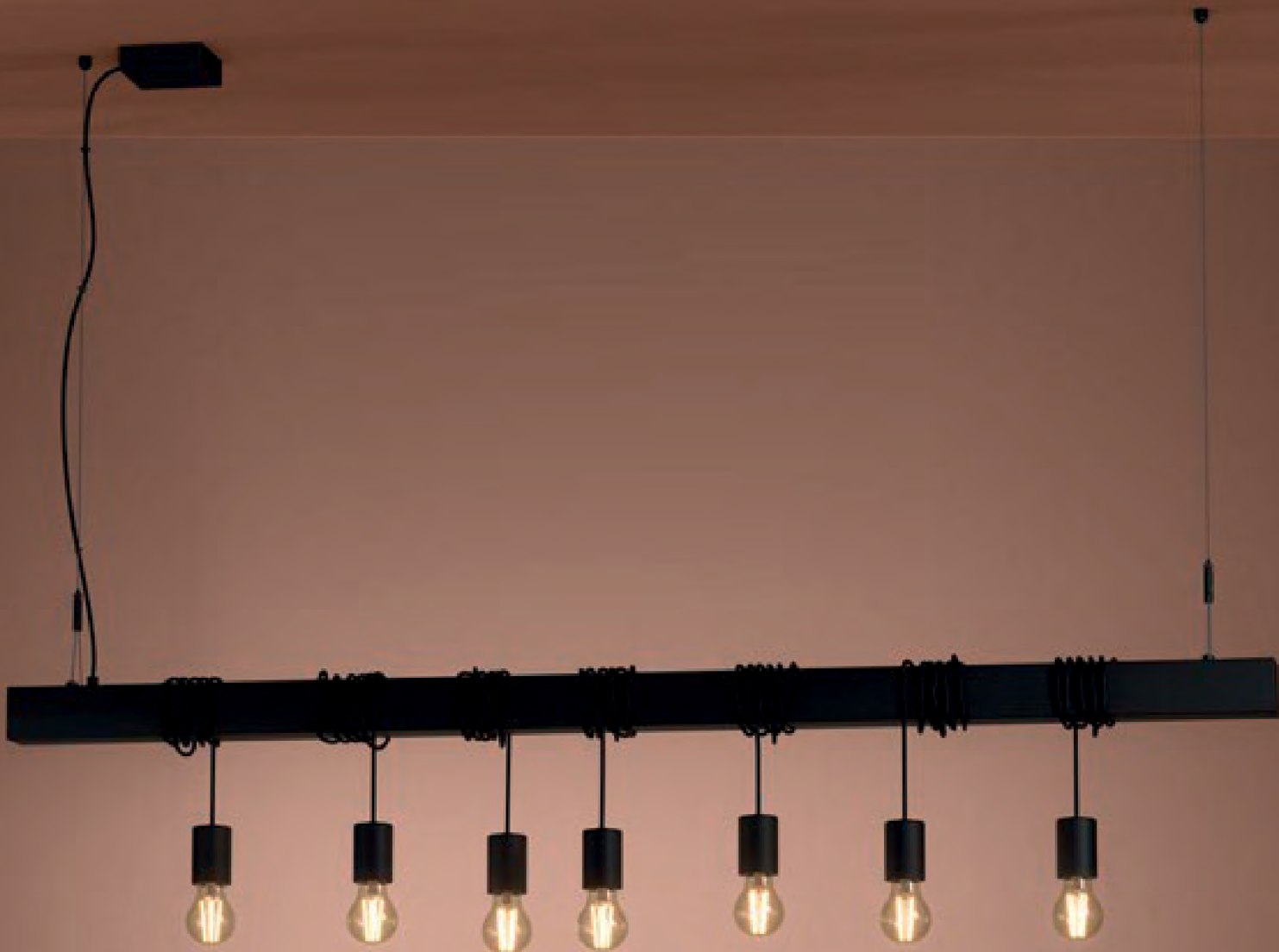

### ▲ 39938 TOWNSHEND-B

Luminario colgante de 7 luces; acero, negro  
*pendant light; steel, black*

L 1500, B 95, H 2000  
E27  
7x 40 W

Incluye lámpara



▲ **390046 UPANEMA**

Luminario colgante de 3 luces; acero, negro; vidrio grabado, blanco  
*pendant light; steel, black; glass etched, white*

L 890, B 165, H 1500  
E27  
3x 28 W

No incluye lámpara



### ▲ 39938 SAVARNA

Luminario colgante de 6 luces; acero, negro; dorado  
*pendant light; steel, black; steel, gold color*

L 1455, B 405, H 1300  
E27  
6x 40 W

No incluye lámpara

# FAMILIAS DE LUMINARIAS

## STANDARD LUMINAIRES

### ENCUENTRO FAMILIAR

Esta gama combina luminarias de techo, pared, suspensión, suelo y mesa. Dale a tus habitaciones un estilo propio con una elegante iluminación.



### FAMILY MEETING

This range combines ceiling, wall, suspended, floor and table luminaires. Give your rooms a consistent and stylish all-round illumination.





900348

# OVERVIEW

LIGHTING FAMILIES

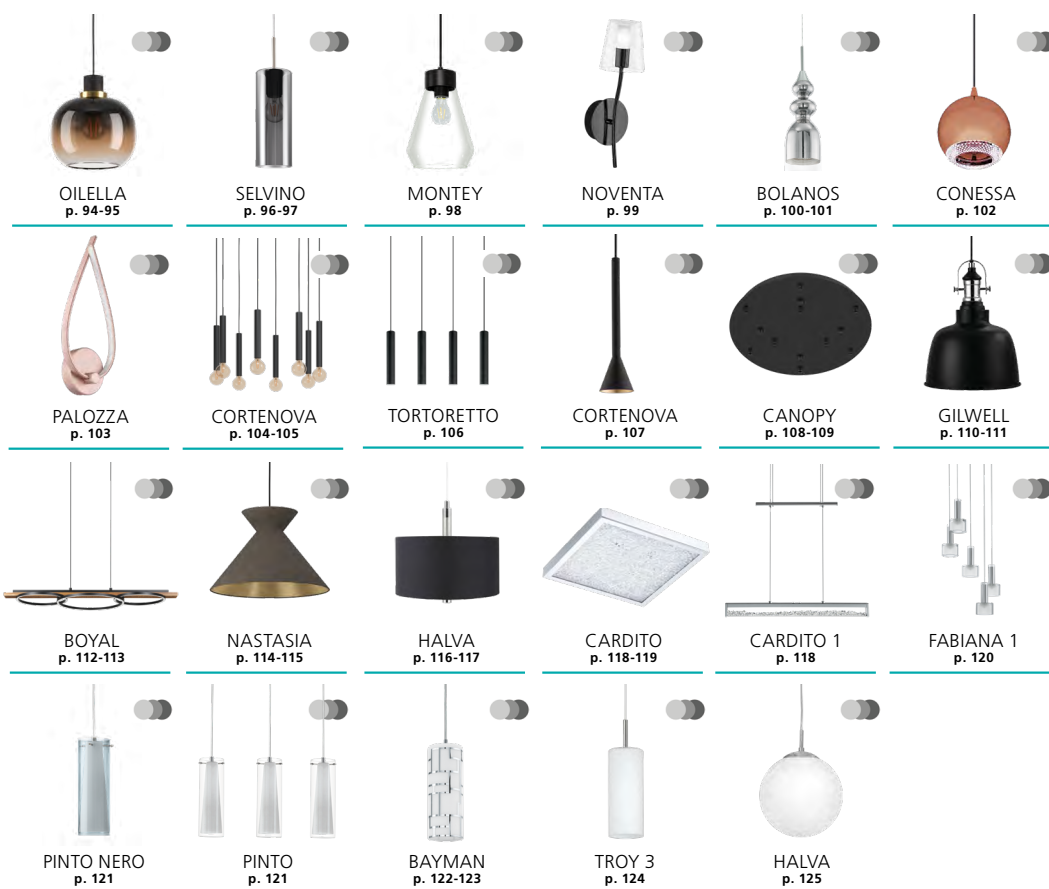

Este producto está disponible en diferentes colores y formas. / This product is available in different colors and shapes.



98058M



### 99614 OILELLA

Luminario colgante de 1 luz; acero, latón; negro-marrón  
 pendant light; steel, black, brass / glass vaporized, black-brown-transparent  
 H 1100, Ø 190

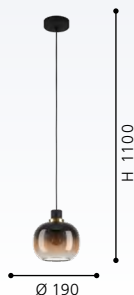
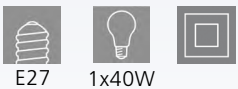

### 99615 OILELLA

Luminario colgante de 3 luces; acero, latón; negro-marrón  
 pendant light; steel, black, brass / glass vaporized, black-brown-transparent  
 L 950, B 190, H 1100

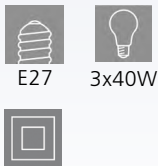

### 99616 OILELLA

Luminario colgante de 1 luz; acero, latón; negro-gris  
 pendant light; steel, black, brass / glass vaporized, black-grey-transparent  
 H 1100, Ø 190

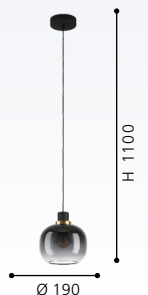
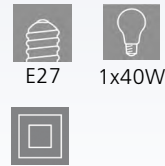



99617



## 99617 OIELLA

Luminario colgante de 3 luces; acero, latón; negro-gris  
*pendant light; steel, black, brass / glass vaporized, black-grey-transparent*

L 950, B 190, H 1100



E27



3x40W





98694



98695

GA00048401

GA00048401

98694

## 98695 SELVINO

Luminario colgante de 3 luces; acero, níquel satinado; cristal vaporizado, negro transparente

*pendant light; steel, satin nickel; glass vaporized, black-transparent*

L 710, B 100, H 1100



E27



3 x15W



L 710

H 1100



E27



15W

## 98694 SELVINO

Luminario colgante de 1 luz; acero, níquel satinado; cristal vaporizado, negro transparente

*pendant light; steel, satin nickel; glass vaporized, black-transparent*

H 1100, Ø 100



Ø 100

H 1100



## 98698 SELVINO

Luminario colgante de 1 luz; acero, níquel satinado; cristal vaporizado, cobrizo  
 pendant light; steel, satin nickel; glass vaporized, copper-coloured

H 1100, Ø 100

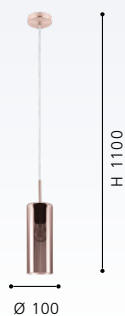

## 98699 SELVINO

Luminario colgante de 3 luces; acero, níquel satinado; cristal vaporizado, cobrizo  
 pendant light; steel, satin nickel; glass vaporized, copper-coloured

L 710, B 100, H 1100

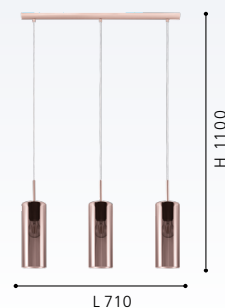



**202125A**



**202125A**

**204366A**

GA000343W0

GA000343W0

## 202125A MONTEY

Luminario colgante de 1 luz; acero, negro mate  
*pendant light; steel, matte black*

H 1830, Ø 210



E26



1 x 60W

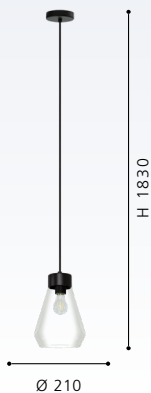

Ø 210

H 1830

## 204366A MONTEY

Luminario colgante de 1 luz; acero, oro cepillado  
*pendant light; steel, brushed gold*

H 2164, Ø 210



E26



1 x 60W



Ø 210

H 2164

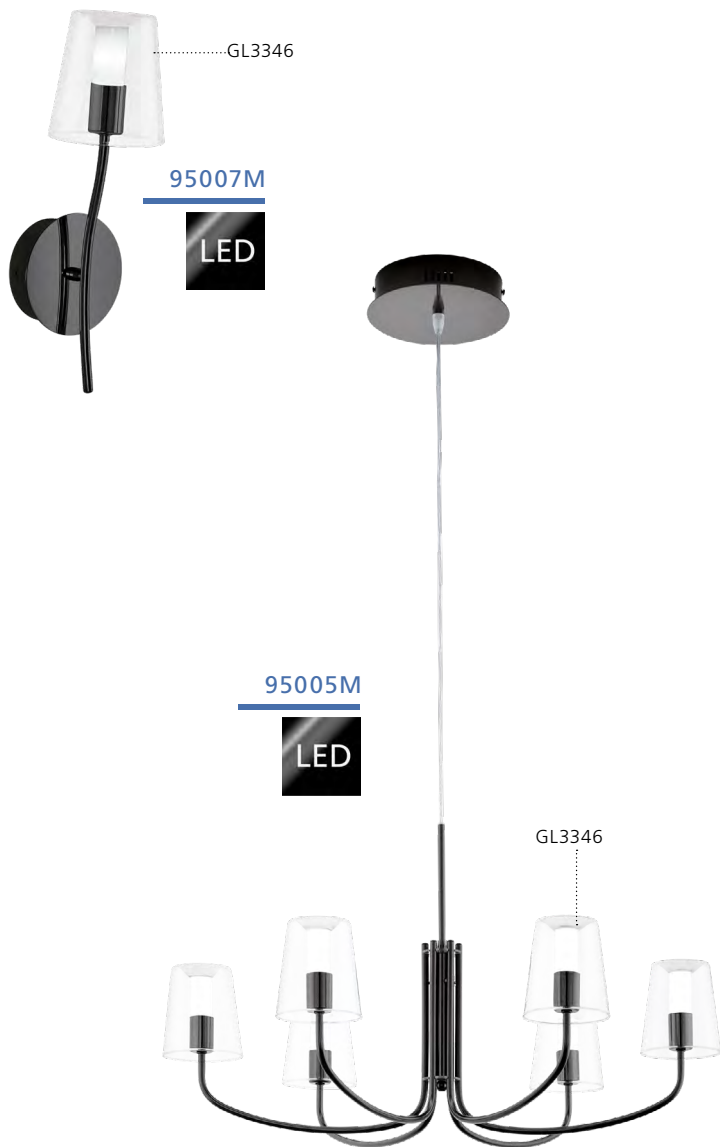

## 95007M NOVENTA

Luminario de pared de 1 luz; acero, níquel, blanco  
*wall light; steel, nickel, white*

L 105, H 360, A 120

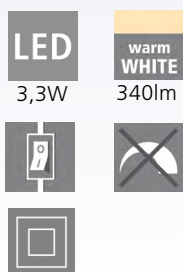

## 95005M NOVENTA

Luminario colgante de 6 luces; acero, níquel, blanco  
*pendant light; steel, nickel, white*

H 1500, Ø 730

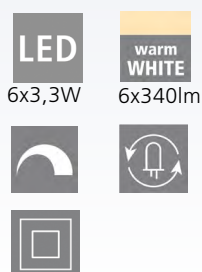



95561M



95555M

LED

GL3380

95561M

LED

GL3380

## 95555M BOLANOS

Luminario colgante de 1 luz; acero, cromo, cristal  
*pendant light; steel, chrome, crystal*

H 1100, Ø 120

LED

6W

warm  
WHITE

250lm



GU10



Incluye Lámpara, reemplazable modelo 201743A

## 95561M BOLANOS

Luminario colgante de 5 luces; acero, cromo, cristal  
*pendant light; steel, chrome, crystal*

H 1500, Ø 500

LED

5x6W

warm  
WHITE

5x250lm



GU10



Ø 120



Ø 500



GL3381

95557M

LED



GL3381

95562M

LED

## 95557M BOLANOS

Luminario colgante de 1 luz; acero, cobre, cristal  
*pendant light; steel, copper, crystal*

H 1100, Ø 120

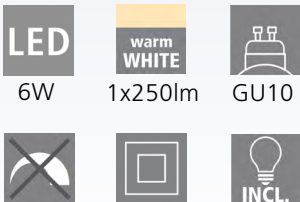

Incluye Lámpara, reemplazable modelo 201743A

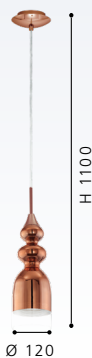

Ø 120

## 95562M BOLANOS

Luminario colgante de 5 luces; acero, cobre, cristal  
*pendant light; steel, copper, crystal*

H 1500, Ø 500



Incluye Lámpara, reemplazable modelo 201743A



Ø 500



202339M

LED

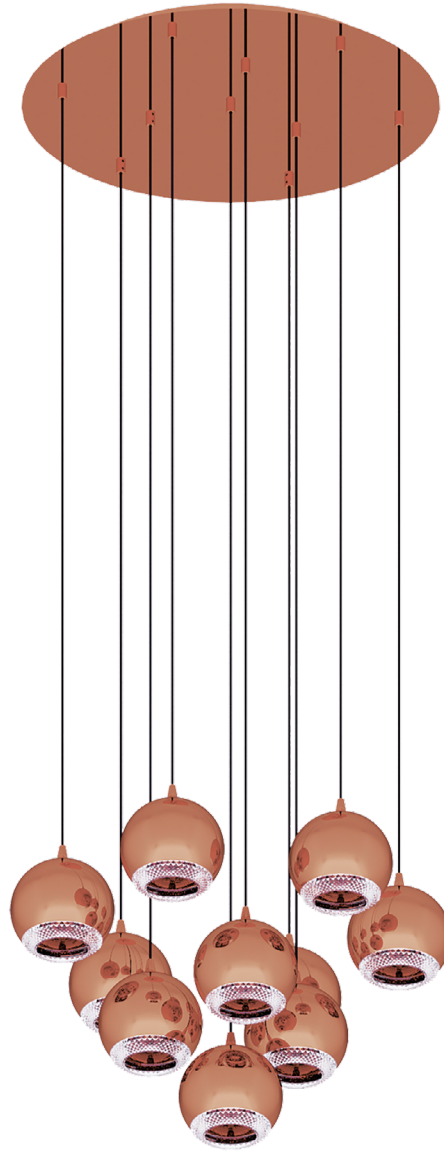

202341M

LED

## 202339M CONESSA

Luminario colgante de 1 luz; acero, cobre  
*pendant light; steel, copper*

H 1100, Ø 130

LED  
 1x 6W  
 warm  
 WHITE  
 1x240lm  
 GU10



INCL.

Incluye Lámpara, reemplazable modelo 201743A



## 202341M CONESSA

Luminario colgante de 10 luces; acero, cobre  
*pendant light; steel, copper*

H 1705, Ø 640

LED  
 10x 6W  
 warm  
 WHITE  
 10x240lm  
 GU10



INCL.

Incluye Lámpara, reemplazable modelo 201743A

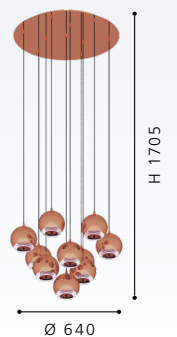



97362M

LED

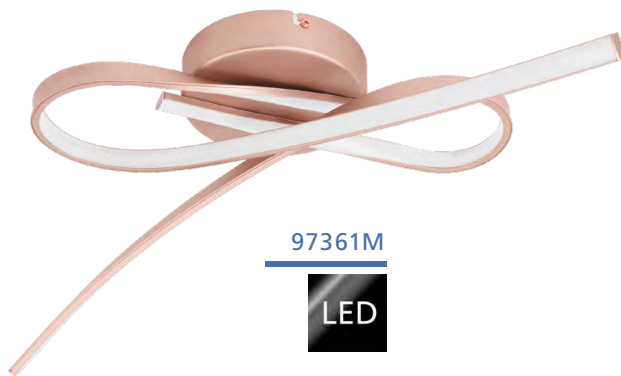

97361M

LED



97363M

LED

## 97362M PALOZZA

Luminario colgante; aluminio, rosa dorado; plástico, blanco  
*pendant light; aluminium, roségold; plastic, white*

L 705, B 315, H 1100

LED  
2x11W

warm  
WHITE  
3000lm



LED integrado

## 97361M PALOZZA

Luminario de techo; aluminio, rosa dorado; plástico, blanco  
*ceiling light; aluminium, roségold; plastic, white*

L 705, B 315, H 125

LED  
1x11W

warm  
WHITE  
3000lm



LED integrado

## 97363M PALOZZA

Luminario de pared; aluminio, rosa dorado; plástico, blanco  
*wall light; aluminium, roségold; plastic, white*

L 170, B 425, A 60

LED  
1x11W

warm  
WHITE  
1500lm



LED integrado



98056M

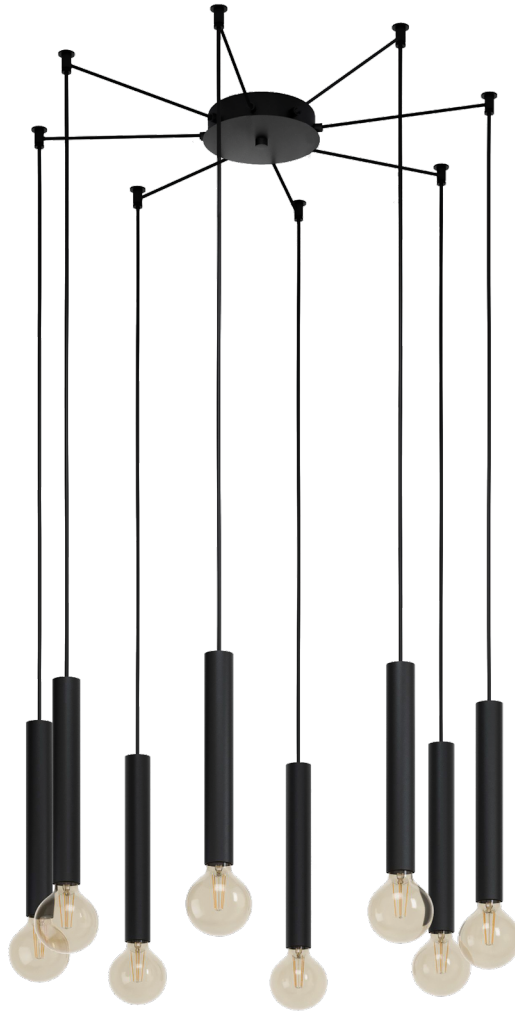

98083



98058M

## 98056M CORTENOVA 98083 CORTENOVA

Luminario colgante de 1 luz; acero, negro  
*pendant light; steel, black*

H 1100, Ø 105



E26



1x 60W



H 1100

Ø 105



E27



8x 60W

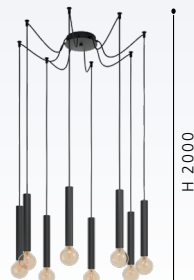

H 2000

Ø 185

## 98058M CORTENOVA

Luminario colgante de 8 luces; acero, negro  
*pendant light; steel, black*

H 1500, Ø 350



E27



5x 60W



H 2000

Ø 350



## 98057 CORTENOVA

Luminario colgante de 4 luces; acero, negro  
*pendant light; steel, black*

L 840, B 60, H 1100



E27



4x 60W





203799M



203618M



203617M



## 203799M TORTORETTO 203618M TORTORETTO 203617M TORTORETTO

Luminario colgante de 1 luz; acero, negro  
*pendant light; steel, black*

Luminario colgante de 5 luces; acero, negro  
*pendant light; steel, black*

Luminario colgante de 4 luces; acero, negro  
*pendant light; steel, black*

H 1500, Ø 95

H 1500, Ø 350

L 975, B 60, H 1500

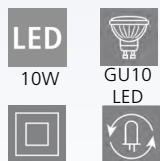

Incluye Lámpara

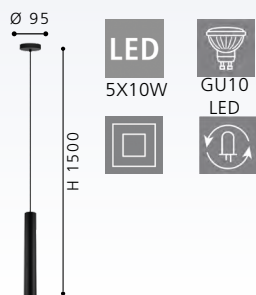

Incluye Lámpara

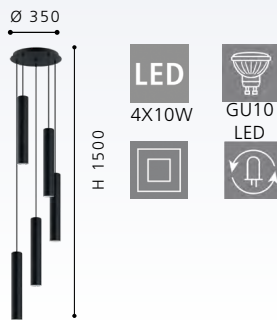

Incluye Lámpara





97606A

LED



97604A

LED



97804M

LED

## 97606A CORTADERAS

Luminario colgante de 5 luces; acero, negro, dorado  
*pendant light; steel, black, gold*

H 1500, Ø 350

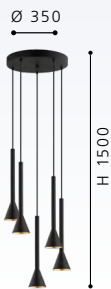

## 97604A CORTADERAS

Luminario colgante de 5 luces; acero, negro, dorado  
*pendant light; steel, black, gold*

H 1500, Ø 95

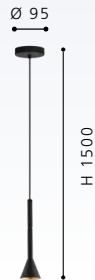
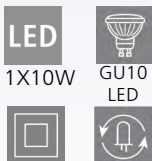

## 97804M CORTADERAS

Luminario de pared de 1 luz; acero, negro, dorado  
*wall light; steel, black, gold*

H 200, Ø 120

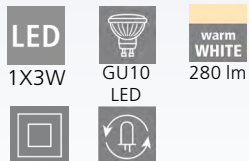

No incluye Lámpara

No incluye Lámpara

No incluye Lámpara

# COLGANTES MULTI PERSONALIDADOS CUSTOMIZED MULTI PENDANTS

## 204102A, 204103A, 204108A

Se incluyen tapas opcionales para cubrir cualquier orificio colgante no utilizado.

*Optional caps are included to cover any unused pendant holes.*



204102A

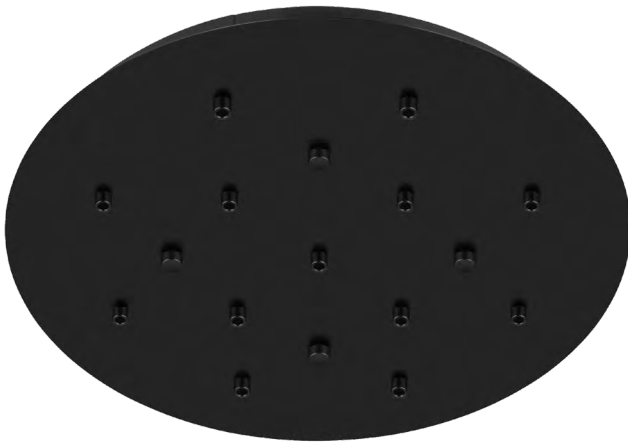

204103A



204108A

## 204102A 9L CANOPY 204103A 13L CANOPY 204108A 16L CANOPY

Canope de 9 luces; acero, negro;  
*canopy; steel, black;*  
adecuado para E26, GU10, G9, E12  
*suitable for E26, GU10, G9, E12*

H 36, Ø 457

Canope de 13 luces; acero, negro;  
*canopy; steel, black;*  
adecuado para E26, GU10, G9, E12  
*suitable for E26, GU10, G9, E12*

H 36, Ø 552

Canope de 16 luces; acero, negro;  
*canopy; steel, black;*  
adecuado para E26, GU10, G9, E12  
*suitable for E26, GU10, G9, E12*

L 489, B 489, H 36

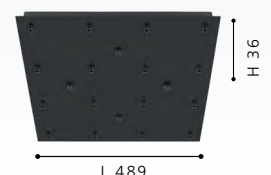
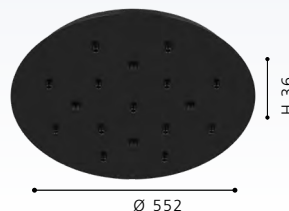
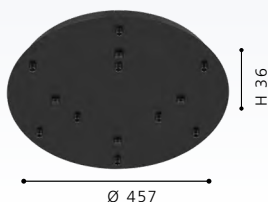

204103A





202423A



GA00106101

204368A

## 202423A GILWELL

Luminario colgante de 1 luz; acero, negro mate, cromo  
*pendant light; steel, matt black, chrome*

H 1830, Ø 250



E26



60W



H 1830

Ø 250

## 204368A GILWELL

Luminario colgante de 1 luz; acero, negro, cromo; vidrio tintado, negro transparente  
*pendant light; steel, black, chrome; smoked glass, black transparent*

H 2328, Ø 380



E26



60W



H 2328

Ø 380



202423A



204922A

LED



99408A

LED



99457A

LED

## 204922A BOYAL

Luminario colgante LED; acero, negro-café rústico, plástico blanco  
*pendant light; steel, wood, black, brown rustic; plastic, white*

L 1010, B 400, H 1975

LED warm WHITE  
 2x12W 2x 1700lm

LED warm WHITE  
 1x16W 2250lm



## 99408A BOYAL

Luminario de techo LED; acero, madera, negro-café rústico, plástico blanco  
*ceiling light; steel, wood, black, brown rustic; plastic, white*

L 780, B 400, H 90

LED warm WHITE LED warm WHITE  
 14W 1700lm 14,5W 1700lm

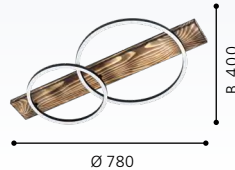

## 99457A BOYAL

Luminario de mesa LED; acero, madera, negro-café rústico, plástico blanco  
*table light; steel, wood, black, brown rustic; plastic, white*

L 300, B 150, H 426, Base: B 110, T 150

LED warm WHITE  
 15W 1700lm

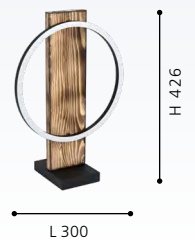



204922A



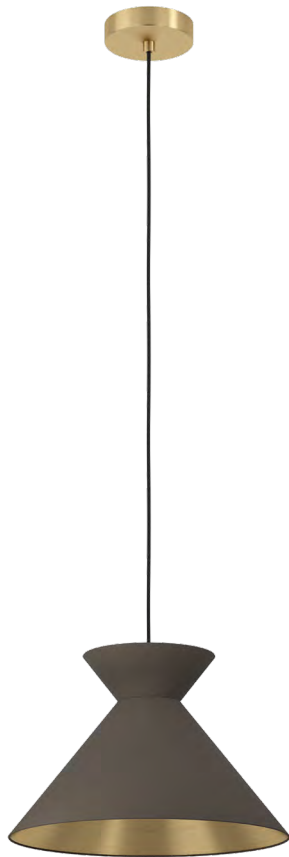

900347



900348

## 900347 NASTASIA

Luminario colgante de 1 luz; acero, negro; textil, capuchino, latón  
*pendant light; steel, black; fabric, cappuccino, brass*

H 1100, Ø 380



E27



1x40W



H 1100

Ø 380

## 900348 NASTASIA

Luminario colgante de 3 luces; acero, negro; textil, capuchino, latón  
*pendant light; steel, black; fabric, cappuccino, brass*

L 1000, B 240, H 1100



E27



3x40W



H 2328

L 1000



900348

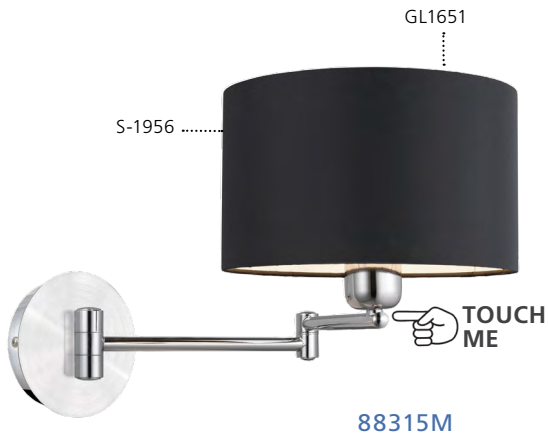

## 88315M HALVA

Luminario de pared de 1 luz; cromo, textil negro  
*wall light; chrome, fabric, black*

H 260, Ø 230, A 595

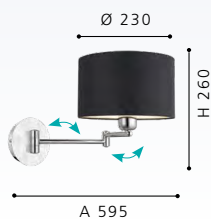
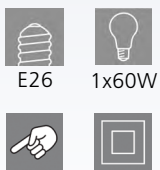

## 88317M HALVA

Luminario de mesa 1 luz; cromo, textil negro  
*tablelight, chrome, fabric, black*

H 470, Ø 290; Base Ø 185

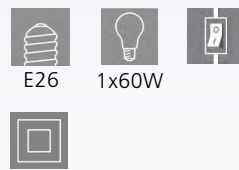

## 88314M HALVA

Luminario colgante de 3 luces; cromo, textil negro  
*pendant light; chrome, fabric, black*

H 1100, Ø 430

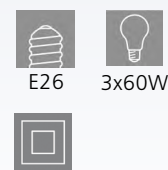

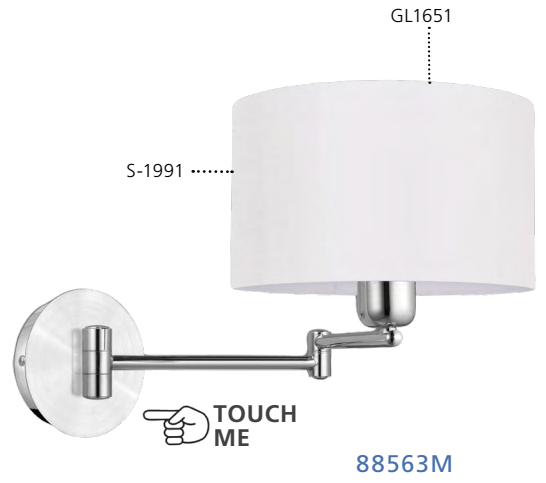

## 88318M HALVA

Luminario de pie de 4 luces; cromo, textil, negro  
*floor light; chrome, fabric, black*

H 1800, Ø 430; Base Ø 250

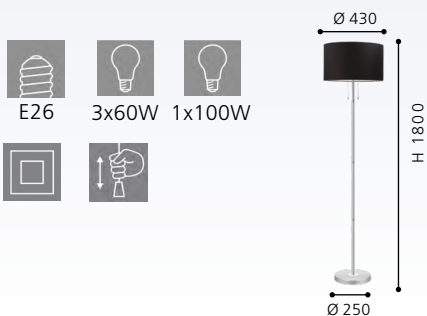

## 88562M HALVA

Luminario colgante de 3 luces; cromo, textil blanco  
*pendant light; chrome, fabric, white*

H 1100, Ø 430

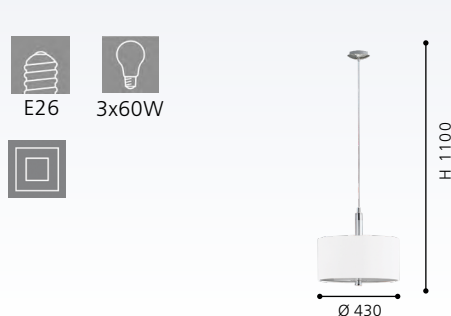

## 88563M HALVA

Luminario de pared de 1 luz; cromo, textil blanco  
*wall light; chrome, fabric, white*

H 260, Ø 230, A 595

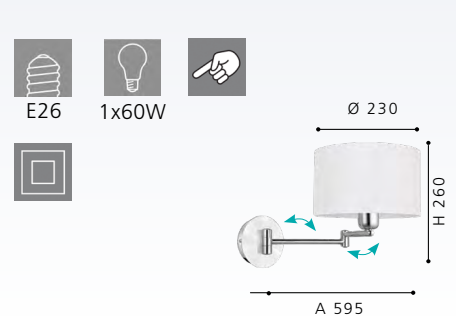



GL2930

92781A

LED

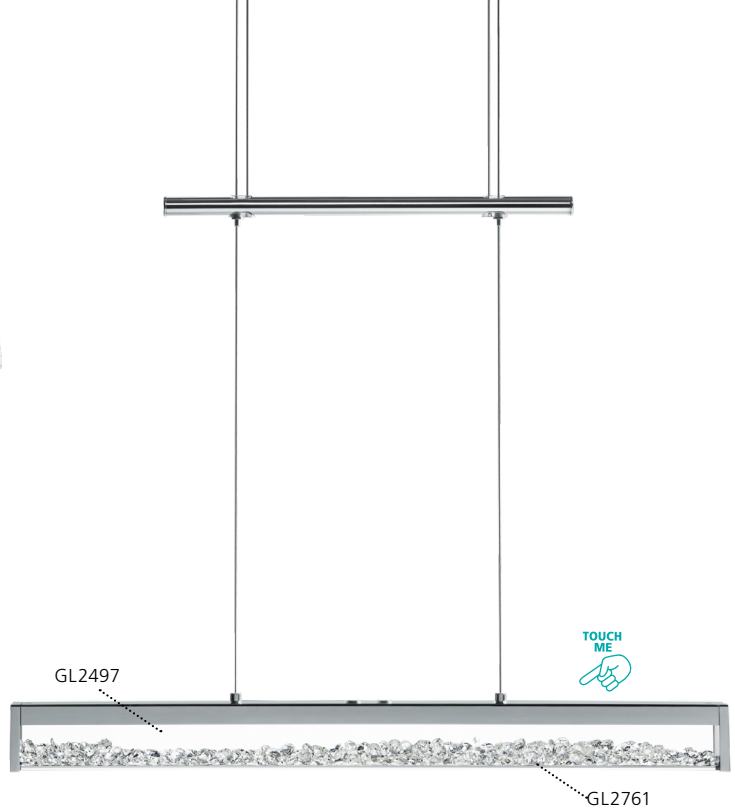

GL2497

TOUCH ME

GL2761

93625M

LED



GL2931

92782A

LED

## 92781A CARDITO

Luminario de techo; acero, cromo, cristal  
ceiling light; steel, chrome; glass, crystal, clear

L 365, B 365, H 75

LED  
21W  
warm  
WHITE  
1550lm



LED integrado

## 92782A CARDITO

Luminario de techo; acero, cromo, cristal  
ceiling light; steel, chrome; glass, crystal, clear

L 470, B 470, H 85

LED  
30W  
warm  
WHITE  
2670lm



LED integrado

## 93625M CARDITO 1

Luminario colgante; aluminio, acero, cromo;  
cristal claro  
pendant light; aluminium, steel, chrome; glass, crystal, clear

L 700, B 80, H 1100

LED  
24W  
tunable  
WHITE  
2000lm

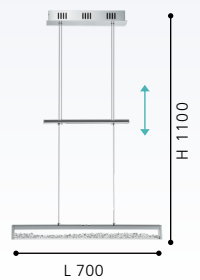

LED integrado



204259A

LED

## 204259A CARDITO

Luminario colgante; aluminio, acero; negro mate, cristal claro  
*pendant light; aluminium, steel, chrome; matte black, crystal, clear*

L 1000, B 125, H 1958

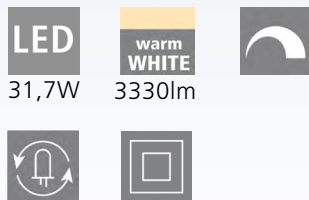

LED integrado

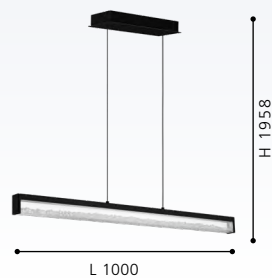



### 93927M FABIANA 1

Luminario colgante de 1 luz; acero, cromo; cristal claro satinado  
*pendant light; steel, chrome; glass, clear, satinated*

H 1100, Ø 130

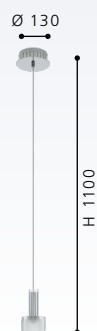
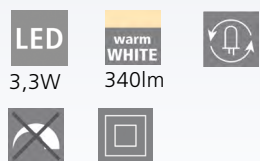

### 93932M FABIANA 1

Luminario de pared de 1 luz; acero, cromo; cristal satinado  
*pendant light; steel, chrome; glass, clear, satinated*

L 90, H 170, A 135

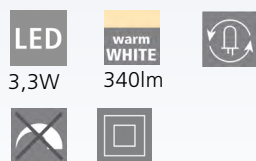

### 93931M FABIANA 1

Luminario colgante de 5 luces; acero, cromo; cristal claro satinado  
*pendant light; steel, chrome; glass, clear, satinated*

H 1100, Ø 350

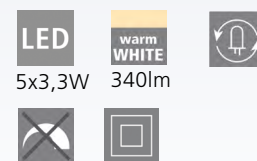



## 90305A PINTO NERO

Luminario colgante de 3 luces; níquel mate, negro transparente, blanco  
*pendant light; steel, satin nickel; smoked glass, opal glass, black-transparent, white*

L 725, H 1100

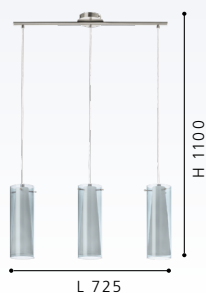

## 90304A PINTO NERO

Luminario colgante de 1 luz; níquel mate, negro transparente, blanco  
*pendant light; steel, satin nickel; smoked glass, opal glass, black-transparent, white*

H 1100, Ø 380



## 20508A PINTO

Luminario colgante de 3 luces; acero, cromo; cristal opalino mate, blanco claro  
*pendant light; steel, chrome; glass, glass opal-matt, clear, white*

L 725, H 1100

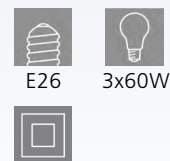



## 92562A BAYMAN

Luminario colgante de 1 luz; cromo, cristal blanco decorado, cromo  
*pendant light; steel, chrome; glass with decoration, white, chrome*

L 1100, B 105



E26



1x 60W



## 92563A BAYMAN

Luminario colgante de 3 luces; cromo, cristal blanco decorado, cromo  
*pendant light; steel, chrome; glass with decoration, white, chrome*

H 1100, B 105, L 720



E26



3x 60W



## 92564A BAYMAN

Luminario de pared de 1 luz; cromo, cristal blanco decorado, cromo  
*wall light; steel, chrome; glass with decoration, white, chrome*

L 180, H 250, A 80



E26



1x 60W

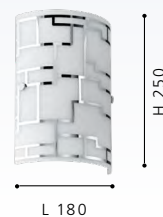



**200227A**

**200228A**



**91973A**

**200227A BAYMAN**

Luminario colgante de 1 luz; cromo, cristal blanco  
*pendant light; chrome, glass, white*  
 L 1500, B 126

**200228A BAYMAN**

Luminario colgante de 3 luces; cromo, cristal blanco  
*pendant light; chrome, glass, white*  
 H 1500, B 126, L 720

**91973A BAYMAN**

Luminario de mesa 1 luz; cromo, cristal blanco  
*table light; chrome, glass white*  
 H 270, Ø 105

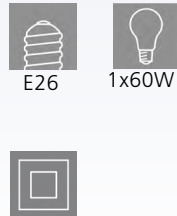
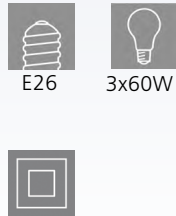
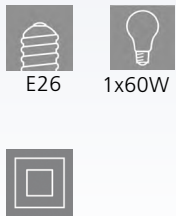



**85977M**



**85978M**



**85981M**

### 85977M TROY 3

Luminario colgante de 1 luz; níquel mate, cristal, blanco satinado  
*pendant light; nickel matt, satinated glass, white*

H 1100, Ø 105, Base: Ø 120



E26



1x60W

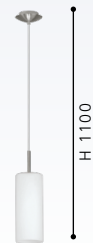

Ø 105

H 1100

### 85978M TROY 3

Luminario colgante de 3 luces; níquel mate, cristal, blanco satinado  
*pendant light; nickel matt, satinated glass, white*

L 720, B 105, H 1100



E26



3x60W



L 720

H 1100

### 85981M TROY 3

Luminario de mesa de 1 luz; níquel mate, cristal, blanco satinado  
*table light; nickel matt, satinated glass, white*

H 460, Ø 105, Base: Ø 120



E26



1x60W



Ø 120

H 460



## 85262M RONDO

Luminario colgante de 1 luz; níquel opalino, cristal, mate  
*pendant light; nickel, crystal, matt*

H 1100, Ø 250



E26



1x60W



## 85263M RONDO

Luminario colgante de 1 luz; níquel opalino, cristal, mate  
*pendant light; nickel, crystal, matt*

H 1100, Ø 300



E26



1x60W



# LUMINARIAS COLGANTES

PENDANT LUMINAIRES

## ILUMINACIÓN SUSPENDIDA

Nuestra amplia variedad de luminarias colgantes contiene diseños clásicos extravagantes para cualquier estilo de decoración. Crea hermosos detalles con tus luminarios favoritos y dale a tu hogar un ambiente único.

## SUSPENDED LIGHTING

Our wide variety of suspended and pendant luminaires contain classical as well as extravagant designs and supply any furnishing style. Set beautiful accents with your favourites and give your home a special atmosphere.



































99654

# OVERVIEW

## PENDANT LUMINAIRES

					
TORRENTES p. 130	ALOBRASE p. 130	CERASELLA p. 131	AGUILARES p. 131	LAGUNITAS p. 132	MARYVILLA p. 133
					
MASETA p. 134	GRADOLI p. 135	ERMUA p. 136	CLIMENE p. 137	SENDERO p. 137	MIRAFLORES p. 138
					
PALTAS p. 138	TOWNSHEND 1 p. 139	FORNES p. 139	NEVADO p. 139	SABALETE p. 140	CAMARGO p. 140
					
CONTRISA p. 141	DEBED p. 142	CORETTO 4 p. 142	RAMON p. 143	VARILLAS p. 143	ROCAMAR p. 144
					
SIRACUSA p. 144	TORONJA p. 145	DIAMOND p. 145	FEDRA p. 145	FALCADO p. 146	MEDUNO p. 146

 Este producto está disponible en diferentes colores y formas. / This product is available in different colors and shapes.



203386A



98291



98291



98614

## 98291 TORRENTES

Luminario colgante de 1 luz; acero, níquel-nero; vidrio ahumado, negro transparente  
*pendant light; steel, nickel-nero; smoked glass, black-transparent*

H 1100, Ø 345



E27



1x40W



E27



1x40W

## 98614 ALOBRASE

Luminario colgante de 1 luz; acero, cromo; vidrio vaporizado, negro transparente  
*pendant light; steel, chrome; glass vaporized, black-transparent*

H 1100, Ø 300



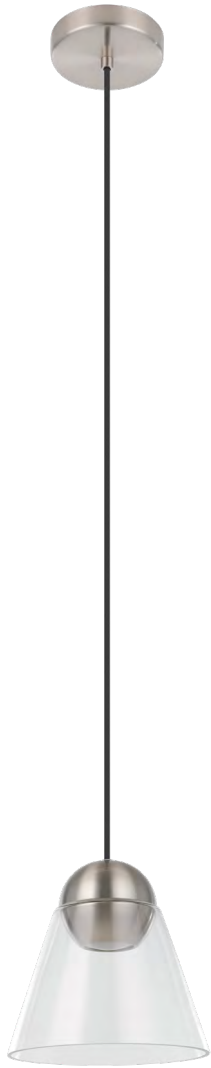

**205644A**



**900196**

## 205644A CERASELLA

Luminario colgante de 1 luz; acero, níquel mate; vidrio claro  
*pendant light; steel, matte nickel; glass, clear*

H 2069, Ø 200

**LED**

10W

**warm  
WHITE**

TBC



GU10



INCL.



## 900196 AGUILARES

Luminario colgante de 3 luces; acero, negro; vidrio vaporizado,  
 negro-gris transparente  
*pendant light; steel, black; glass vaporized, black-grey-transparent*

H 1100, Ø 430



E27



3x40W

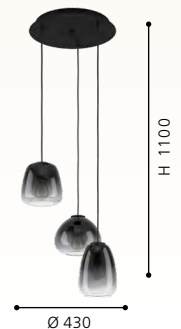

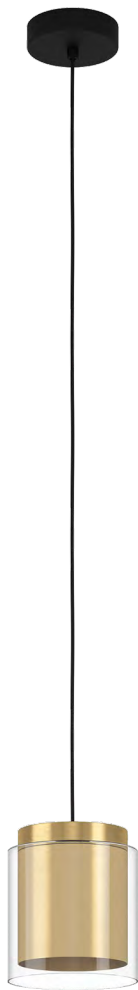

99651



99654

## 99651 LAGUNITAS

Luminario colgante de 1 luz; acero, negro, latón, oro; vidrio claro  
*pendant light; steel, black, brass, gold; glass, clear*

H 1100, Ø 150



E26



1x40W



## 99654 LAGUNITAS

Luminario colgante de 3 luces; acero, negro, latón, oro; vidrio claro  
*pendant light; steel, black, brass, gold; glass, clear*

L 910, B 150, H 1100



E27



3x40W





900551



900549

## 900551 MARYVILLA

Luminario colgante de 3 luces; acero, bronceado; vidrio vaporizado, transparente, dorado  
*pendant light; steel, black, bronzed; glass vaporized, clear, gold*

L 870, B 170, H 1100



E27



3x40W



## 900549 MARYVILLA

Luminario colgante de 1 luz; acero, bronceado; vidrio vaporizado, transparente, dorado  
*pendant light; steel, black, bronzed; glass vaporized, clear, gold*

H 1100, Ø 170



E27



1x40W





99633



99634

## 99633 MASETA

Luminario colgante de 1 luz; acero, negro; vidrio ahumado, negro-transparente  
 pendant light; steel, black; smoked glass, black-transparent

H 1100, Ø 225



E27



1x40W



H 1100

Ø 225



E27



3x40W

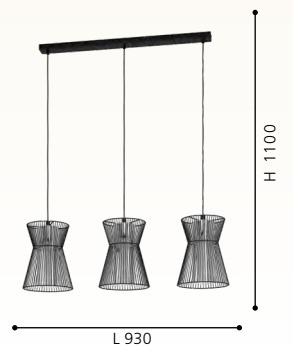

H 1100

L 930



203386A

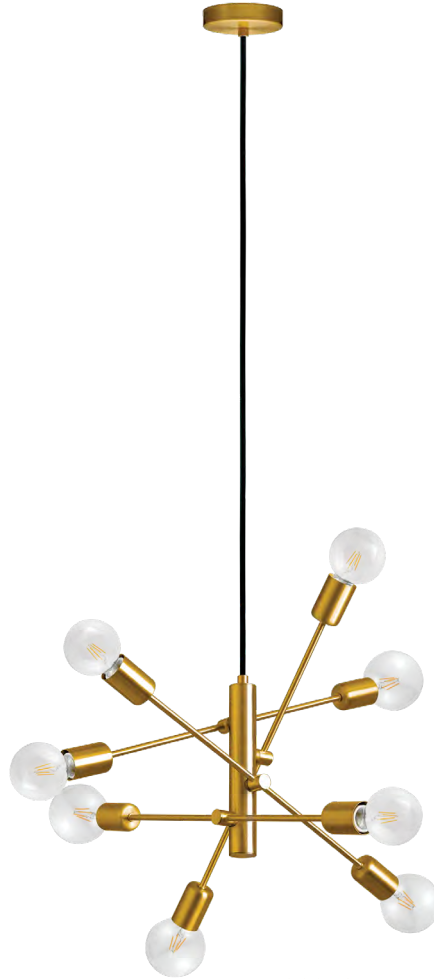

203795A



98017M

## FAMILIA GRADOLI

Los brazos de la lámpara se pueden girar individualmente.

*The lamp arms can be swiveled individually.*

### 203386A GRADOLI

Luminario colgante de 8 luces; acero, negro; cromo

*pendant light; steel, black; chrome*

H 1100, Ø 710



E26



8 x 60W

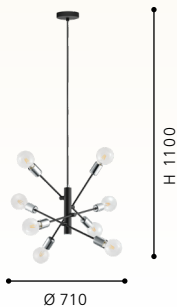

### 203795A GRADOLI

Luminario colgante de 8 luces; acero, oro cepillado

*pendant light; steel, brushed gold; chrome*

H 2140, Ø 551



E26



8 x 60W

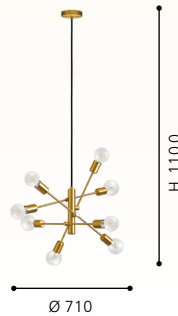

### 98017M GRADOLI

Luminario colgante de 8 luces; acero, blanco; cromo

*pendant light; steel, white; chrome*

H 1100, Ø 710



E26



8 x 60W

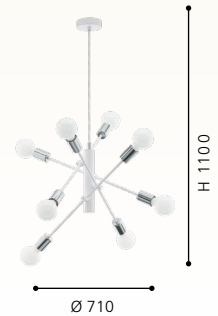



98836A

LED

## 98836A ERMUA

Luminario colgante; acero, madera, negro, café; plástico, blanco  
 pendant light; steel, wood, black, brown; plastic, white

L 1000, B 165, H 1100







27W      3850lm



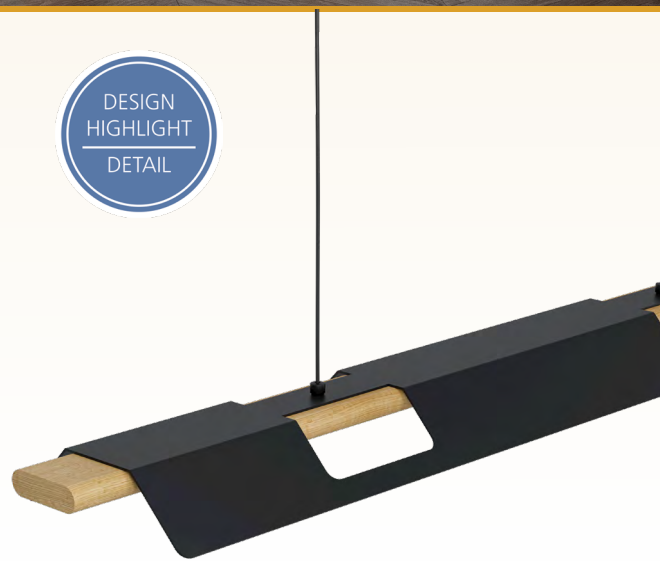
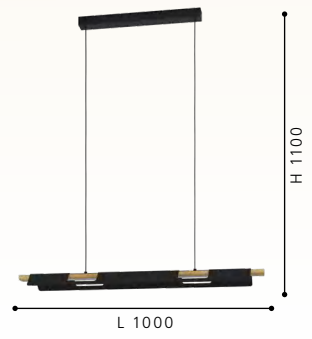



**39344M**



**96194M**

## 39344M CLIMENE

Luminario colgante; aluminio, acero, madera, aluminio cepillado, níquel satinado, plástico  
*pendant light; aluminium, steel, wood, brushed aluminium, satin nickel, plastic*

L 940, B 45, H 1500



LED integrado



## 96194M SENDERO

Luminario colgante de 2 luces; acero, níquel satinado; madera, maple  
*pendant light; steel, satin nickel / wood, maple*

L 775, B 250, H 1300

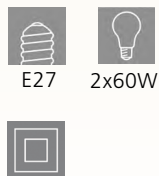



97745M



95216M

## 97745M MIRAFLORES

Luminario colgante; aluminio, acero, dorado, plástico  
 pendant light; aluminium, steel, gold-coloured; plastic, white

L 865, B 80, H 1200

**LED**  
 2x 8,5W

**warm WHITE**  
 2000lm



LED integrado

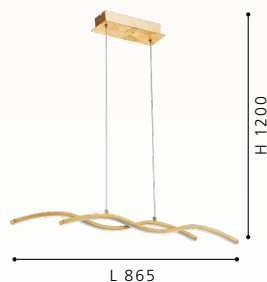

## 95216M PALTAS

Luminario colgante de 9 luces; acero, dorado, negro mate  
 pendant light; steel, gold, matt black

H 1500, Ø 700

 E26

 9x60W

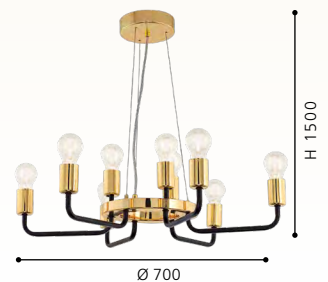



93909M

LED



96331M

LED



49139M

## 49139M TOWNSHEND 1

Luminario colgante de 3 luces; acero, negro, cromo

*pendant light; steel, black, chrome*

H 1760, L 804



GU10



3X7W

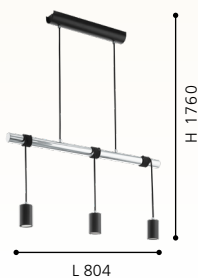

L 804

## 93909M FORNES

Luminario colgante LED; acero, níquel negro

*pendant light; steel, black nickel*

H 1100, L 970



LED

27W



warm WHITE

2160lm



L 970

## 96331M NEVADO

Luminario colgante de LED; aluminio, cromo, plástico, blanco

*pendant light; aluminum, chrome, plastic white*

H 1200, L 890



LED

26,5W



warm WHITE

2500lm

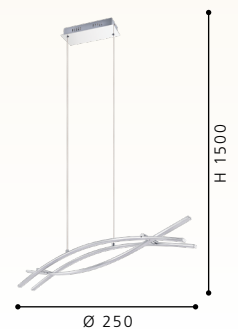

Ø 250



**98364M**



**98192A**

**98364M**

## SABALETE

Esta luminaria es móvil en todas las direcciones.  
*This luminaire is moveable in all directions.*

### 98364M SABALETE

Luminario colgante de 3 luces; acero, negro; vidrio opalino mate, blanco  
*pendant light; steel, black; glass opal-matt, white*

H 1100, Ø 465



E26



3x60W

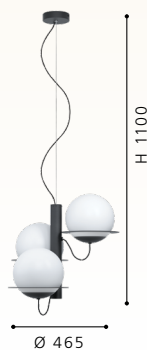

H 1100

Ø 465

### 98192A CAMARGO

Luminario colgante de 1 luz; acero, negro; vidrio blanco opalino  
*pendant light; steel, black; glass opal-matt, white*

H 1100, Ø 280



E26



1x60W



H 1100

Ø 280



## 900379 CONTRISA

Luminario colgante de 1 luz; acero, gris  
*pendant light; steel, grey*

H 1100, Ø 380



E27



1x40W



## 900381 CONTRISA

Luminario colgante de 1 luz; acero, gris  
*pendant light; steel, grey*

H 1100, Ø 520



E27



1x40W



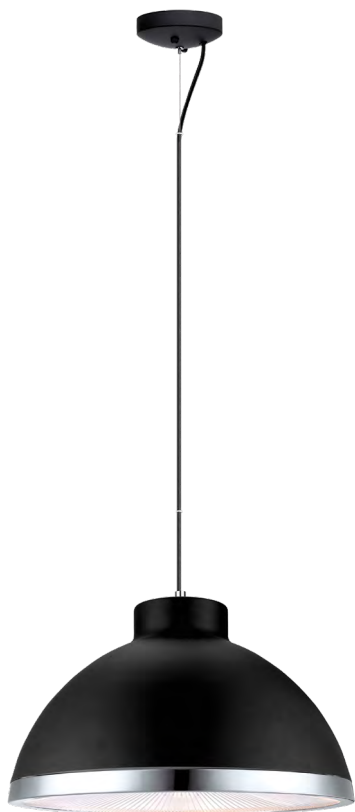

**200259A**

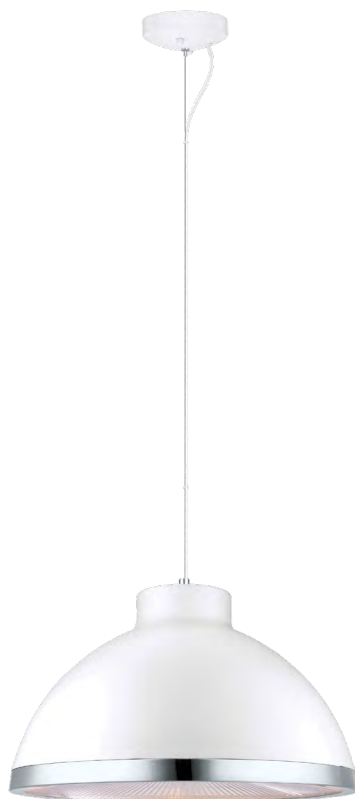

**200258A**

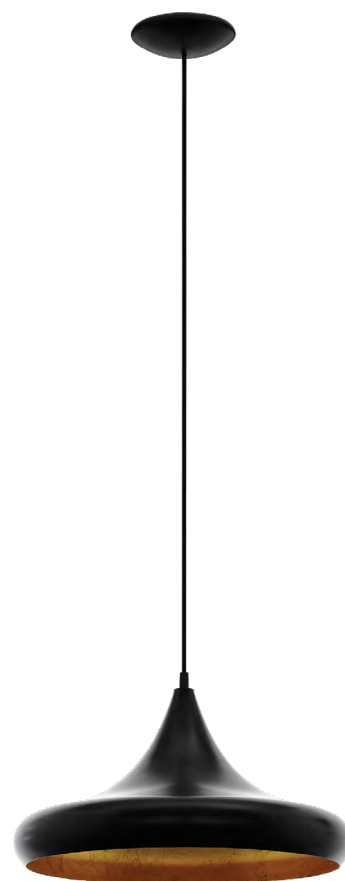

**97739M**

### 200259A DEBED

Luminario colgante de 2 luces; acero, negro, cromada; acrilico, transparente  
*pendant light; steel, black, chrome; plastic, clear*

H 1100, Ø 500



E26



2x100W



### 200258A DEBED

Luminario colgante de 2 luces; acero, blanco, cromada; acrilico, transparente  
*pendant light; steel, white, chrome; plastic, clear*

H 1100, Ø 500



E26



2x100W



### 97739M CORETTO 4

Luminario colgante de 1 luz; acero, negro, dorado  
*pendant light; steel, black, gold*

H 1100, Ø 400



E26



1x60W

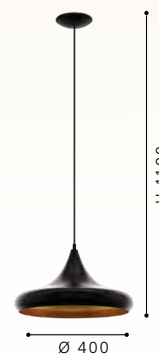



**98351M**



**98313M**

## 98351M RAMON

Luminario colgante de 1 luz; acero, negro  
*pendant light; steel, black*

H 1100, Ø 310

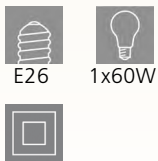

## 98313M VARILLAS

Luminario colgante de 3 luces; acero, negro; textil con recortes, negro, dorado  
*pendant light; steel, black; fabric with cut-outs, black, gold*

H 1100, Ø 530

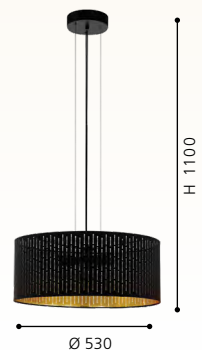
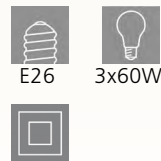



**94589M**

**39509M**

## 94589M ROCAMAR

Luminario colgante de 1 luz; acero, cobre; cristal  
*pendant light; steel, copper; crystal*

H 1100, Ø 190



E26



1x60W



Ø 190

## 39509M SIRACUSA

Luminario colgante de 10 luces; acero, marrón, cristal, cobre  
*pendant light; steel, brown; glass, copper-coloured*

H 1500, Ø 615



E26



10x60W



Ø 615

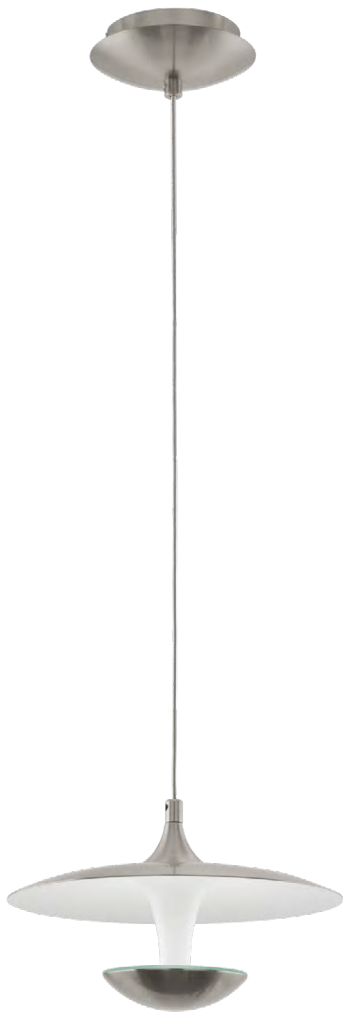

95955M



ET1161

GL2014

90695A

GL2436

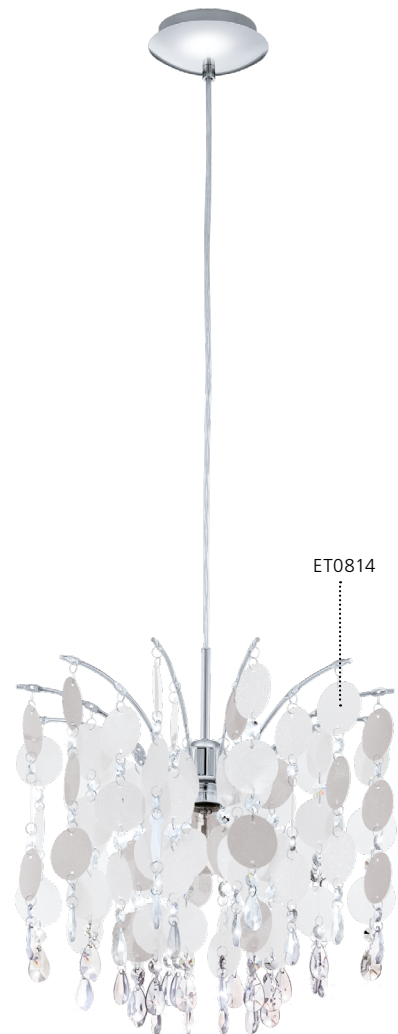

ET0814

91046A

## 95955M TORONJA

Luminario colgante; acero, níquel mate, blanco  
*pendant light; steel, nickel-matt white*

H 1500, Ø 220

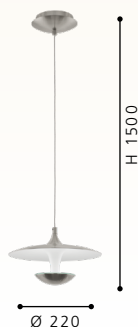

## 90695A DIAMOND

Luminario colgante de 1 luz; cromo, cristal  
*pendant light; chrome, crystal*

H 1100, Ø 105

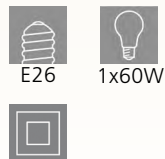

## 91046A FEDRA

Luminario colgante de 1 luz; cromo, nacar, cristal, nacarado  
*pendant light; chrome; crystal, pearly, clear*

H 1100, Ø 380

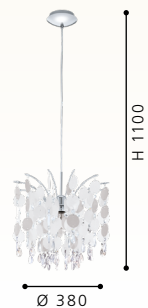



39117M



39126M

## 39117M FALCADO

Luminario colgante de 5 luces; acero, cromo, vidrio negro, transparente  
*pendant luminaire; steel, chrome, glass black, transparent*

H 1100, Ø 710



E12



5x40W



H 1100

Ø 710

## 39126M MEDUNO

Luminario colgante de 6 luces; acero, cromo, vidrio negro  
*pendant luminaire; steel, chrome, glass black*

H 1100, Ø 640



E12



6x40W



H 1100

Ø 640

No incluye lámpara

No incluye lámpara



43627



























## TREND & STYLE COLLECTION

Vintage, el estilo de diseño de interiores popular desde hace varios años, ha adornado los hogares de nuestros clientes durante varios años y continúa exhibiendo una versatilidad sorprendente, que refleja el encanto de las últimas décadas. Nos hemos inspirado en este estilo en nuestros diseños de luminarias, lo que permite a nuestros clientes agregar un poco más de carácter a sus hogares con algunos de nuestros accesorios de iluminación. Las tendencias de diseño de interiores son tan ricas y diversas como la vida misma, y cada año se descubren y reinterpretan nuevas tendencias. Constantemente se crean nuevas tendencias y estilos combinando y recomblando diferentes materiales y diseños. Este catálogo busca mostrar esta gama casi ilimitada de ideas y opciones.

Vintage, the enduringly popular interior design style, has adorned the homes of our customers for several years now and continues to exhibit stunning versatility, reflecting the charm of past decades. We have taken inspiration from this style in our luminaire designs, allowing our customers to add a little extra character to their homes with some of our lighting fixtures. Interior design trends are as rich and diverse as life itself, and new trends are discovered and reinterpreted every year. New trends and styles are constantly being created by combining and recombining different materials and designs. This catalogue seeks to showcase this near-limitless range of ideas and options.

# OVERVIEW

TREND & STYLE LUMINAIRES

					
MILLIGAN p. 149-150	BARNSTAPLE p. 151	PRIDDY p. 152	EMBLETON p. 152	BROMWICH p. 152	LUBENHAM p. 153
					
COMBWICH p. 153	COMBWICH 1 p. 153	TOWNSHEND 4 p. 154	CORETTO 2 p. 155	HAPTON p. 155	CARLTON p. 156
					
CARLTON 1 p. 156-158	AUCKLAND p. 159	MATLOCK p. 159	HORNWOOD 2 p. 160	TOWNSHEND 5 p. 161-163	BASILDON p. 164
					
PADSTOW p. 165	COTTINGHAM p. 166	CLEVEDON p. 167	NEWTON p. 167	RAMPSIDE p. 168	MARYSVILLE p. 168
					
DEMBLEBY p. 169	BORDESLEY p. 169	EDALE p. 170			

 Este producto está disponible en diferentes colores y formas. / This product is available in different colors and shapes.

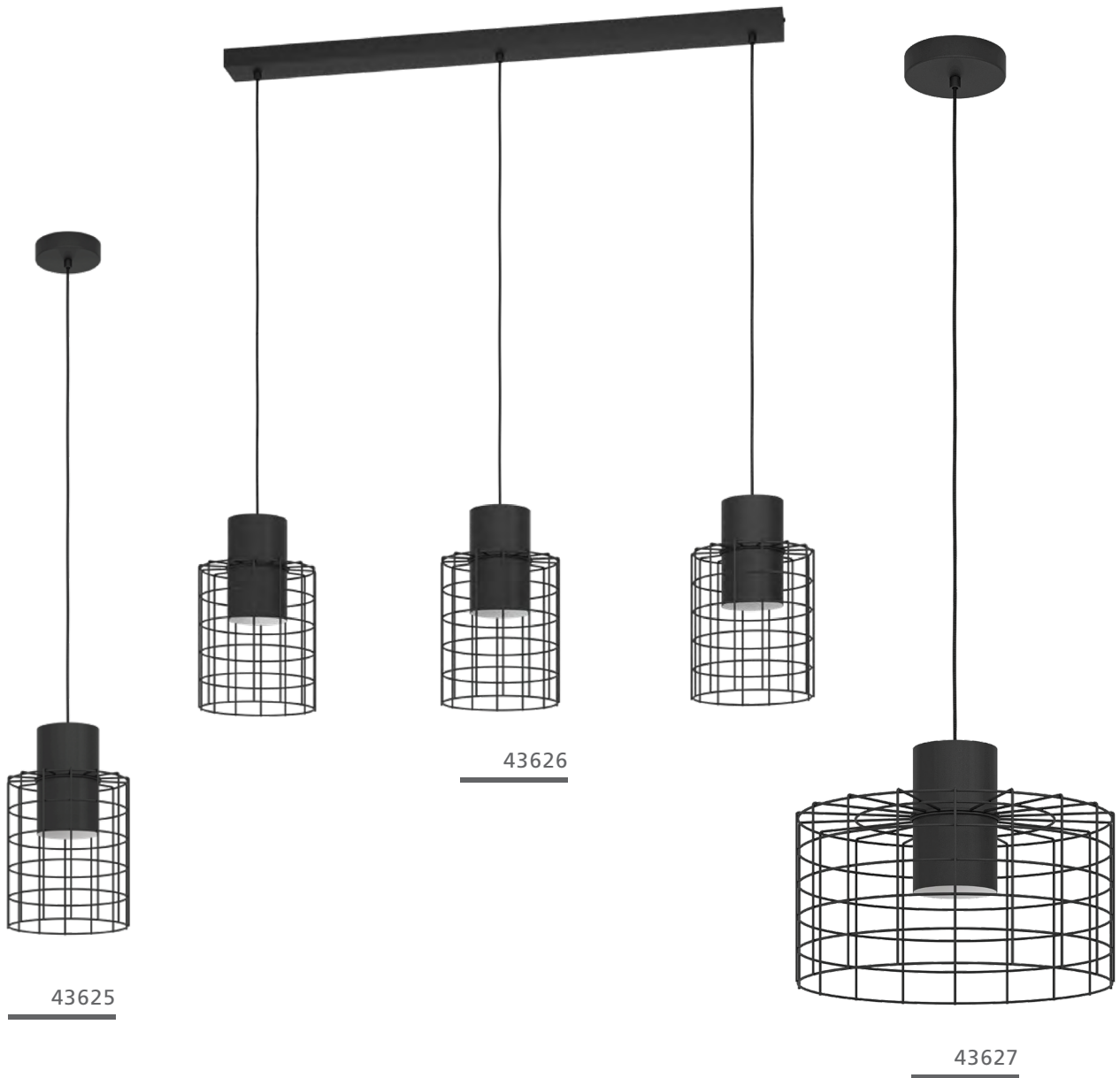

### 43625 MILLIGAN

Luminario colgante de 1 luz; acero, negro, blanco  
*pendant light; steel, black, white*

H 1100, Ø 200

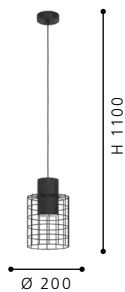

### 43626 MILLIGAN

Luminario colgante de 3 luces; acero, negro, blanco  
*pendant light; steel, black, white*

L 1030, B 200, H 1100

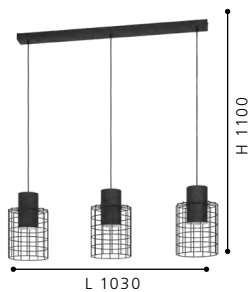

### 43627 MILLIGAN

Luminario colgante de 1 luz; acero, negro, blanco  
*pendant light; steel, black, white*

H 1100, Ø 380

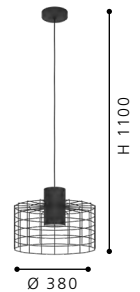

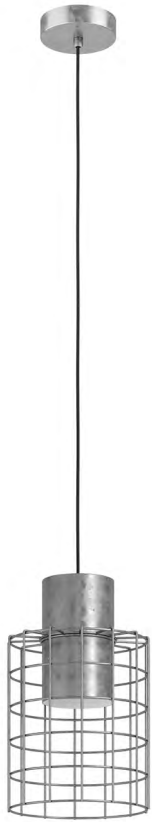

43647

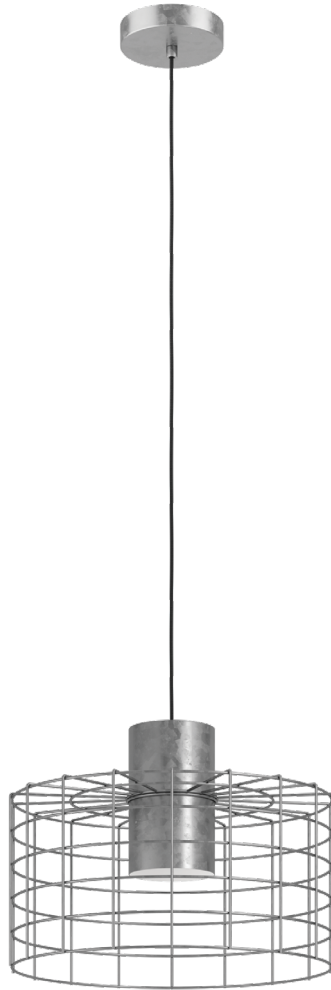

43649

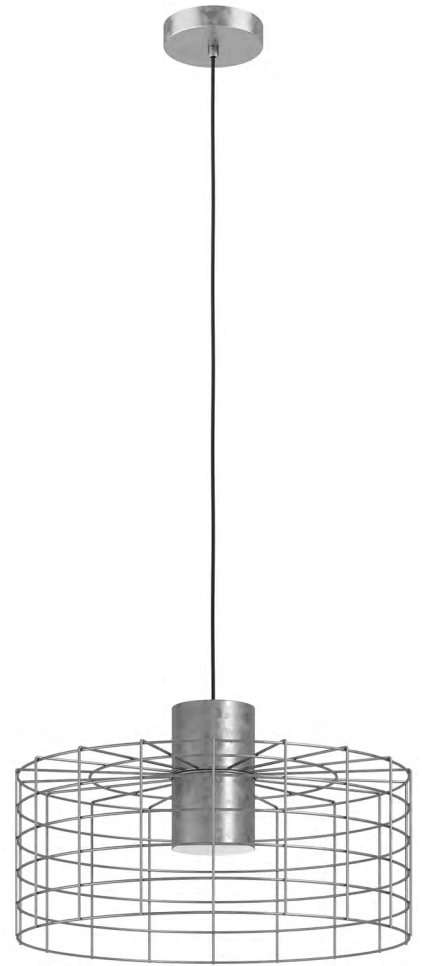

43651

### 43647 MILLIGAN

Luminario colgante de 1 luz; acero, zincado, blanco  
*pendant light; steel, zinc-plated, white*

H 1100, Ø 200



E27



1x40W

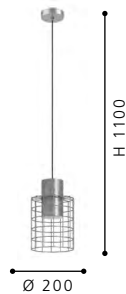

Ø 200

### 43649 MILLIGAN

Luminario colgante de 1 luz; acero, zincado, blanco  
*pendant light; steel, zinc-plated, white*

H 1100, Ø 380



E27



1x40W

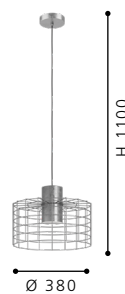

Ø 380

### 43651 MILLIGAN

Luminario colgante de 1 luz; acero, zincado, blanco  
*pendant light; steel, zinc-plated, white*

H 1100, Ø 480



E27



1x40W

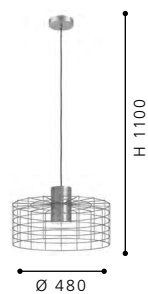

Ø 480



43649

### 49718M BARNSTAPLE

Luminario de mesa; madera, acero, patina marrón, negro; acero, terminado zinc desgastado  
*table light; wood, steel, brown-patina, black; steel, used look Zinc*

B 175, H 400, Base: Ø 180



E26



1x40W



DESIGN  
HIGHLIGHT  
DETAIL





**49467M**



**202308M**



**49146M**

### 49467M PRIDDY

Luminario colgante de 7 luces; acero, negro, blanco  
 pendant light; steel, black, white

H 1100, Ø 385



E27



7x60W



H 1100

Ø 385

### 202308M EMBLETON

Luminario colgante de 1 luz; acero, negro  
 pendant light; steel, black

H 1500, Ø 460



E26



1x60W



H 1500

Ø 460

### 49146M BROMWICH

Luminario colgante de 1 luz; acero, negro  
 pendant light; steel, black

H 1100, Ø 300



E26



1x60W



H 1100

Ø 300



43162M



43215M



GA00048001

43302

### 43162M LUBENHAM

Luminario colgante de 1 luz; acero, madera, negro, café  
*pendant light; steel, wood, black, brown*

H 1100, Ø 300

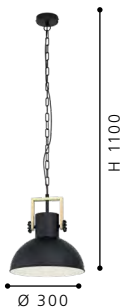

Ø 300

### 43215M COMBWICH

Luminario colgante de 1 luz; acero, negro, crema  
*pendant light; steel, black, creme*

H 1100, Ø 530



Ø 530

### 43302 COMBWICH 1

Luminario colgante de 1 luz; acero, negro; vidrio ópalo, blanco brillante  
*pendant light; steel, black; glass opal, shiny white*

H 1100, Ø 380



Ø 380



43152



49859M

### 43152 TOWNSHEND 4

Luminario de pared de 1 luz; acero, negro, café  
wall light; steel, black, brown

L 80, H 190, A 185

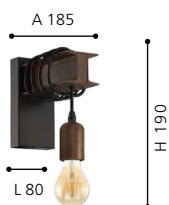

### 49859M TOWNSHEND 4

Luminario colgante de 6 luces; acero, café  
pendant light; steel, brown

L 1005, B 70, H 1100





94742M

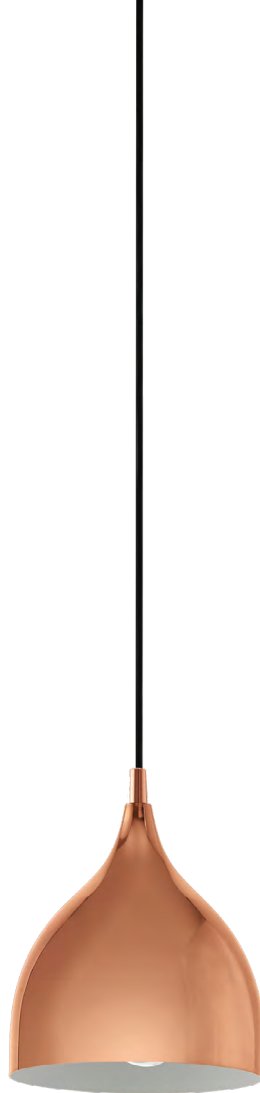

94743A

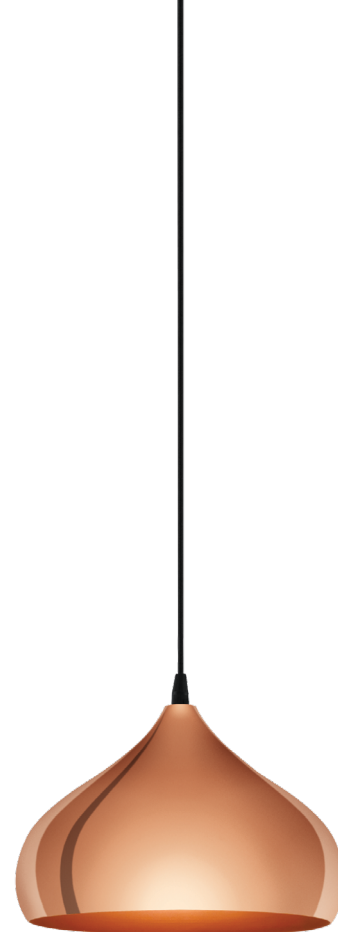

49449

### 94742M CORETTO 2

Luminario colgante de 1 luz; acero, cobre  
*pendant light; steel, copper*

H 1100, Ø 400

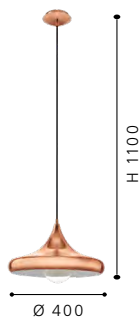

### 94743A CORETTO 2

Luminario colgante de 1 luz; acero, cobre  
*pendant light; steel, copper*

H 1100, Ø 170



### 49449 HAPTON

Luminario colgante de 1 luz; acero, cobre  
*pendant light; steel, copper*

H 1100, Ø 290

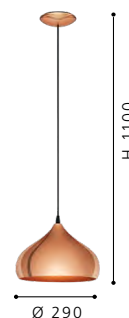



**49935**



**49257M**

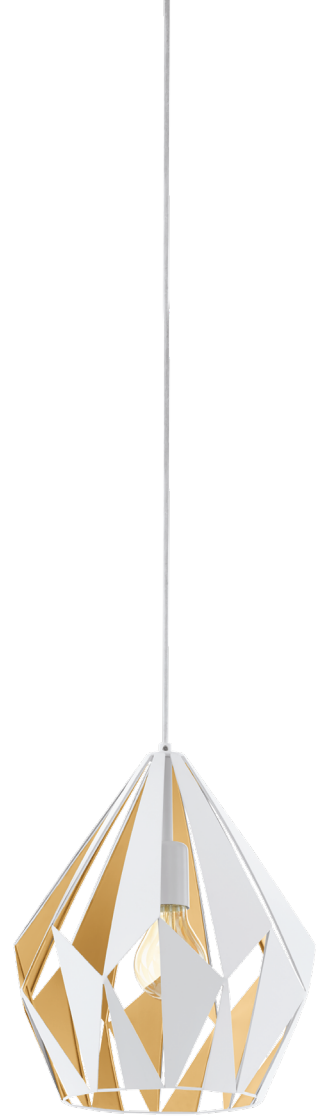

**49932**

### 49935 CARLTON

Luminario colgante de 1 luz; acero, plata  
*pendant light; steel, silver*

H 1100, Ø 310



### 49257M CARLTON

Luminario colgante de 1 luz; acero, negro  
*pendant light; steel, black*

H 1100, Ø 310



### 49932 CARLTON 1

Luminario colgante de 1 luz; acero, blanco, oro, miel  
*pendant light; steel, white, honey gold*

H 1100, Ø 310

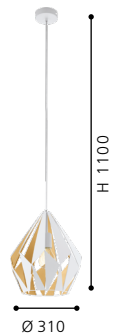

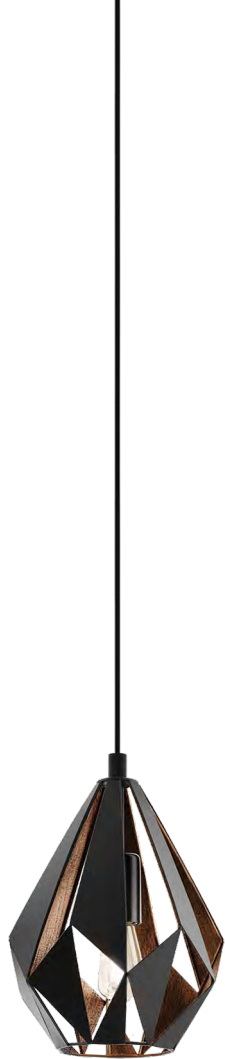

49997



49878



49992

### 49997 CARLTON 1

Luminario colgante de 1 luz; acero, negro, cobre  
*pendant light; steel, black, copper*

H 1100, Ø 205

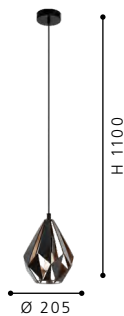

### 49878 CARLTON 1

Luminario colgante de 1 luz; acero, negro, cobre  
*pendant light; steel, black, copper*

H 1500, Ø 385



### 49992 CARLTON 1

Luminario de pared de 1 luz; acero, negro, cobre  
*wall light; steel, black, copper*

L 205, H 330, A 220





49991

### 49991 CARLTON 1

Luminario colgante de 3 luces; acero, negro, cobre  
*pendant light; steel, black, copper*

L 805, B 205, H 1100



E27



3x60W



L 805

H 1100

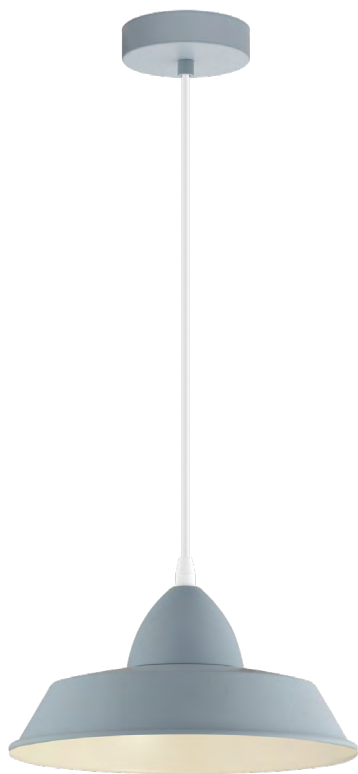

**49052M**



**43825**

### 49052M AUCKLAND

Luminario colgante de 1 luz; acero, azul pastel  
*pendant light; steel, pastel light-blue*

H 1500, Ø 260



E26



1x60W

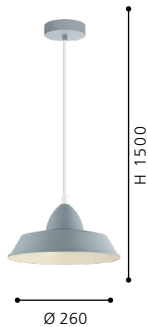

### 43825 MATLOCK

Luminario colgante de 1 luz; acero, gris, negro  
*pendant light; steel, grey, black*

H 1100, Ø 380



E27



1x40W

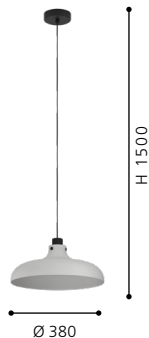

DESIGN  
HIGHLIGHT  
DETAIL





43606



## 43606 HORNWOOD 2

Luminario colgante de 3 luces; acero, madera, negro; vidrio vaporizado, negro-transparente  
*pendant light; steel, wood, black; glass vaporized, black-transparent*  
 L 780, B 150, H 1100



E27



3x40W

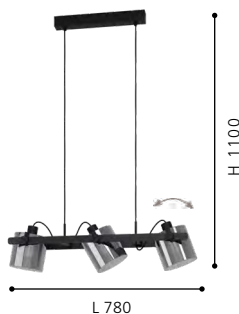

## DETAIL HORNWOOD 2

Las pantallas de la luminaria se pueden girar individualmente.

*The heads of this luminaire can be swiveled individually.*





43132



43135



43131

### 43132 TOWNSHEND 5

Luminario colgante de 4 luces; acero, madera, negro, café  
*pendant light; steel, wood, black, brown*

L 700, B 200, H 1100

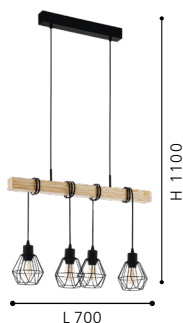

### 43131 TOWNSHEND 5

Luminario de techo de 3 luces; acero, madera, negro, café  
*ceiling light; steel, wood, black, brown*

L 550, B 200, H 360



### 43135 TOWNSHEND 5

Luminario de pared de 1 luz; acero, madera, negro, café  
*wall light; steel, wood, black, brown*

L 140, H 245, A 240





43133



43137



43136

### 43133 TOWNSHEND 5

Luminario colgante de 6 luces; acero, madera, negro, café  
*pendant light; steel, wood, black, brown*

L 1000, B 200, H 1100



### 43136 TOWNSHEND 5

Luminario de mesa de 1 luz; acero, madera, negro, café  
*table light; steel, wood, black, brown*

L 220, B 155, H 500, Base: Ø 155



### 43137 TOWNSHEND 5

Luminario de pie de 2 luces; acero, madera, negro, café  
*floor light; steel, wood, black, brown*

L 400, B 250, H 1665, Base: Ø 250





43134

### 43134 TOWNSHEND 5

Luminario colgante de 9 luces; acero, madera, negro, café  
*pendant light; steel, wood, black, brown*

L 1500, B 200, H 1100



E27



9x60W

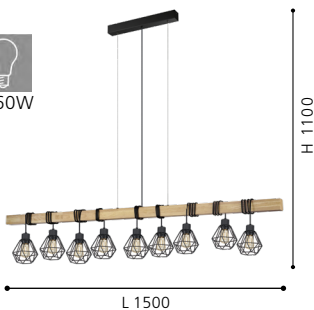

## DETAIL BASILDON

El aro de metal negro se puede ajustar individualmente.

*The black metal ring is individually adjustable.*



### 43461 BASILDON

Luminario colgante de 1 luz; acero, madera, negro, café  
*pendant light; steel, wood, black, brown*

L 190, B 160, H 1100

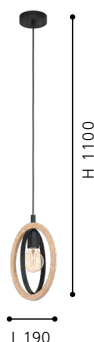

### 43462 BASILDON

Luminario colgante de 3 luces; acero, madera, negro, café  
*pendant light; steel, wood, black, brown*

L 780, B 160, H 1100



### 43464 BASILDON

Luminario de mesa de 1 luz; acero, madera, negro, café  
*wall light; steel, wood, black, brown*

L 190, B 160, H 345, Base: Ø 155





43363

43364M



43364M

### 43364M PADSTOW

Luminario colgante de 1 luz; acero, madera, negro, natural  
*pendant light; steel, wood, black, natural*

H 1100, Ø 455



E27



1x60W

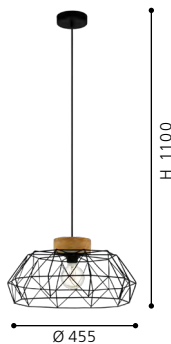

H 1100

Ø 455

### 43363 PADSTOW

Luminario de techo de 1 luz; acero, madera, negro, natural  
*ceiling light; steel, wood, black, natural*

H 205, Ø 455



E27



1x60W



H 205

Ø 455



43328



43329

### 43328 COTTINGHAM

Luminario colgante de 1 luz; acero, negro  
pendant light; steel, black

H 1100, Ø 370



E27

1x40W



Ø 370

### 43329 COTTINGHAM

Luminario colgante de 3 luces; acero, negro  
pendant light; steel, black

H 1300, Ø 485



E27

3x40W



Ø 485



49141M



49479A

### 49141M CLEVEDON

Luminario colgante de 1 luz; acero, negro  
*pendant light; steel, black*

H 1100, Ø 240



E27



1x60W



H 1100

Ø 240

### 49479A NEWTOWN

Luminario colgante de 3 luces; acero, negro  
*pendant light; steel, black*

H 1100, Ø 380



E27



3x60W



H 1100

Ø 380



43256



GL3946

43335

### 43256 RAMPSIDE

Luminario colgante de 1 luz; acero, negro  
*pendant light; steel, black*

H 1380, Ø 110



### 43335 MARYSVILLE

Luminario colgante de 1 luz; acero, negro, vidrio  
 vaporizado, ámbar  
*pendant light; steel, black, glass vaporized, amber*

H 1100, Ø 325





### 43261 DEMBLEBY

Luminario colgante de 1 luz; acero, negro; madera, natural  
*pendant light; steel, black; wood, natural*

H 1100, Ø 320



### 43216M BORDESLEY

Luminario colgante de 1 luz; acero, negro; madera, natural  
*pendant light; steel, black; wood, natural*

H 1100, Ø 350



### 43217 BORDESLEY

Luminario colgante de 3 luces; acero, negro; madera, natural  
*pendant light; steel, black; wood, natural*

L 910, B 210, H 1100





43782



FSC



43783



FSC

### 43782 EDALE

Luminario colgante de 6 luces; acero, negro, café; textil, capuchino

*pendant light; steel, wood, black, brown; fabric, cappuccino*

L 1080, B 510, H 1100



E27



6x40W



L 1080

H 1100

### 43783 EDALE

Luminario de pared de 1 luz; acero, negro, café; textil, capuchino

*wall light; steel, wood, black, brown; fabric, cappuccino*

L 150, H 215, A 195



E27



1x40W



L 150

H 215

A 195



43782

# LUMINARIAS DE PARED Y TECHO

## WALL & CEILING LUMINAIRES

### NUESTRA COLECCIÓN

La gama de luminarias para paredes y techos va desde diseños simples hasta diseños inusuales. No importa si es para el área de entrada, el pasillo o sala de estar éstas luminarias brindan la luz adecuada creando una atmósfera especial en tu hogar.

### OUR ALL-ROUNDERS

The range of wall and ceiling luminaires goes from simple to unusual designs. No matter if for the entrance area, hallway or your living rooms – these luminaires give the right light.

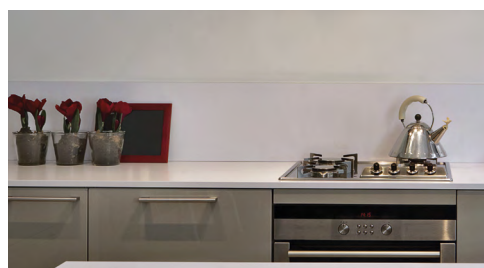

# OVERVIEW

## WALL & CEILING LUMINAIRES



TORTORETO  
p. 174-175



RIBAS  
p. 176



LASANA  
p. 176-177



COMPETA 1  
p. 178



LERIDA  
p. 178



MELDOLA  
p. 178



CARPI 1  
p. 179



GRIMALDINO  
p. 180



VALLASPRA  
p. 181



MAROJALES  
p. 181



DAMBERA  
p. 182



ORMOND  
p. 182



TAZZOLI  
p. 183

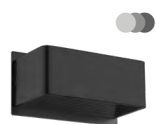

SANIA 3  
p. 184-185



ADRI 3  
p. 186



JABALOYAS  
p. 187



ELIZONDO  
p. 187



NOMO  
p. 188



PAUSIA  
p. 188



Este producto está disponible en diferentes colores y formas. / This product is available in different colors and shapes.



62544A



62545A



62559A

### 62544A TORTORETO

Luminario de techo; acero, negro mate  
ceiling light; steel, matte black

H 275, Ø 115

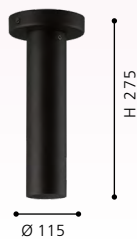

No incluye lámpara

### 62545A TORTORETO

Luminario de techo; acero, negro mate  
ceiling light; steel, matte black

H 425, Ø 115



No incluye lámpara

### 62559A TORTORETO

Luminario de techo; acero, negro mate  
ceiling light; steel, matte black

H 225, Ø 115

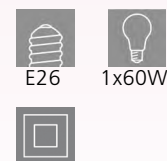



62561A

## 62561A TORTORETO

Luminario de techo; acero, negro mate  
*ceiling light; steel, matte black*

H 425, Ø 115



E26



1x60W



Ø 115

No incluye lámpara



203919M



94634M



94633M

## 203919M RIBAS

Luminario de pared/techo; acero inoxidable, aluminio, níquel satinado; plástico, blanco  
*wall/ceiling luminaire; stainless steel, aluminium, satin nickel; plastic, white*

L 390, B 365, H 65



LED

21.8W



warm  
WHITE  
2120lm

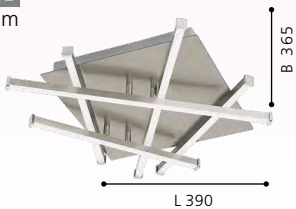

L 390

## 94634M LASANA

Luminario de techo; aluminio, acero, blanco  
*ceiling light; aluminium, steel, white*

H 160, Ø 220

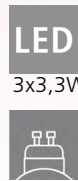

LED

3x3,3W



warm  
WHITE  
792lm



GU10



H 160

Ø 220

Incluye Lámpara

## 94633M LASANA

Luminario de techo; aluminio, acero, blanco  
*ceiling light; aluminium, steel, white*

H 160, Ø 220

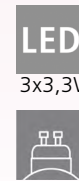

LED

3x3,3W



warm  
WHITE  
792lm



GU10



H 160

Ø 220

Incluye Lámpara

LED integrado



94634M





ET2477

203129M



203921M



96299M



## 203129M COMPETA 1 96299M LERIDA

Luminario de techo LED; acero, blanco, plástico, blanco, plata  
*ceiling light; steel, white, plastic, white, silver*

Ø 340, H 91

Luminario de techo de 1 luz; acero, blanco, cromo, vidrio satinado  
*ceiling light; steel, white, chrome, satinated glass*

Ø 316, H 89

## 203921M MELDOLA

Luminario de techo LED; acero, blanco, plata  
*ceiling light; steel, white, silver*

Ø 445, H 145

LED  
16W  
neutral  
WHITE  
1300lm



LED integrado

LED  
12W  
warm  
WHITE  
1070lm



LED integrado

LED  
26,6W  
warm  
WHITE  
2700lm



LED integrado



201701M



201699M



## 201701M CARPI 1

Luminario pared/techo LED; acero, plástico, iridescente, blanco, plástico blanco  
*wall & ceiling light; steel, plastic, iridescent, white, plastic, white*

Ø 300, A 75

LED  
10,8W

neutral  
WHITE  
1130lm

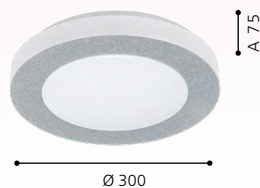

LED integrado

## 201699M CARPI 1

Luminario pared/techo LED; acero, plástico, iridescente, blanco, plástico blanco  
*wall & ceiling light; steel, plastic, iridescent, white, plastic, white*

Ø 300, A 75

LED  
10,8W

neutral  
WHITE  
1130lm

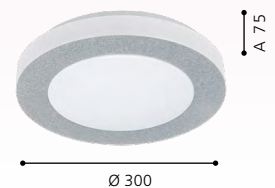

LED integrado



99388A

## 99388A GRIMALDINO

Luminario de techo de 2 luces; negro-café, plástico blanco  
*ceiling light; black, brown, plastic white*

H 132, Ø 409



E26



2x25W





**97792M**



GA000476W0

**204336A**

## 97792M VALLASPRA

Luminario de techo de 2 luces; acero, champán, vidrio opalino mate, blanco  
*wall / ceiling light; steel, champagne; glass opal-matt, white*

L 350, B 165, H 190



E12



2x40W

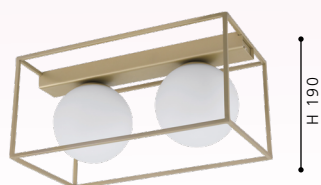

L 350

H 190



E26



2x40W



## 204336A MAROJALES

Luminario de techo de 2 luces; acero, oro cepillado, cristal claro  
*pendant light; steel, brushed gold, crystal clear*

L 557, B 180, H 280



L 557

H 280



## 203785A DAMBERA

Luminario de pared LED; acero, plástico, negro  
*wall light; steel, plastic, black*

Ø 390, B 120, H 340

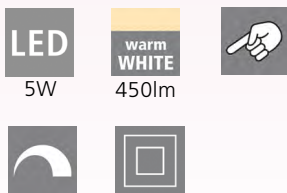

LED integrado

## 203784A ORMOND

Luminario de pared de LED; acero, aluminio, negro mate  
*wall light; steel, aluminum, black matt*

Ø 330, B 120, H 360



LED integrado



96566M

LED



96567M

LED



96566M, 96567M

These luminaires have a USB-connection.

Éstas luminarias tienen conexión USB.

## 96566M TAZZOLI

Luminario de pared LED; acero, plástico; blanco  
*wall light; steel, plastic; white*

L 65, H 300, A 160

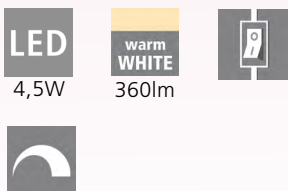

LED integrado



L 65

H 300

## 96567M TAZZOLI

Luminario de pared LED; acero, plástico; níquel satinado, negro  
*wall light; steel, plastic; satin nickel, black*

L 65, H 300, A 160



LED integrado



L 65

H 300



202633A

LED



202634A

LED

### 202633A SANIA 3

Luminario de pared LED; aluminio, negro  
*wall light; aluminum, black*

L 115, H 120, A 103

LED  
5.63W 480lm

warm  
WHITE

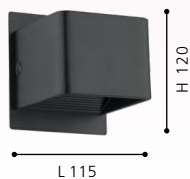

LED integrado

### 202634A SANIA 3

Luminario de pared LED; aluminio, negro  
*wall light; aluminum, black*

L 210, H 115, A 103

LED  
8.5W 720lm

warm  
WHITE

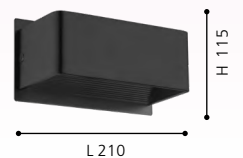

LED integrado



202635A



96204M



## 202635A SANIA 3

Luminario de pared LED; aluminio, negro  
*wall light; aluminum, black*

L 115, H 120, A 103

LED  
8.5W

warm  
WHITE  
720lm



L 210

LED integrado

## 96204M SANIA 3

Luminario de pared; aluminio, blanco  
*wall light; aluminium, white*

L 365, H 80, A 100

LED  
12W

warm  
WHITE  
1200lm



L 365

LED integrado



98064M

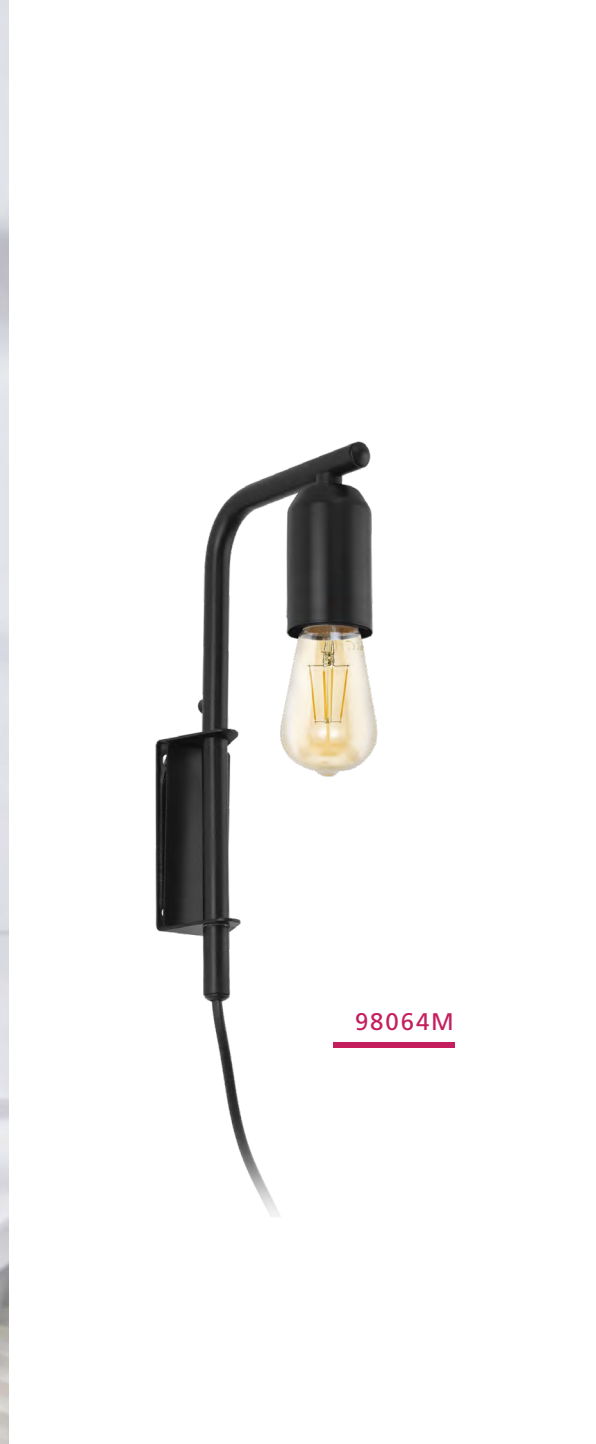

98064M

## 98064M ADRI 3

Luminario de pared de 1 luz, acero; negro  
*wall light, steel; black*

L 40, H 260, A 145



E26



1x60W





**39654M**



**98755**

## 39654M JABALOYAS

Luminario de pared de 1 luz, acero; negro, dorado  
*wall light, steel; black, gold*

L 160, H 630, A 185



E26



60W



L 160

H 630



E14



40W

## 98755 ELIZONDO

Luminario de pared de 1 luz; acero, negro, oro  
*wall light; steel, black, gold*

L 80, H 270, A 115



L 80

H 270



## 20507M NOMO

Luminario de pared; acero, níquel mate; vidrio opalino, blanco  
*walllight; steel, nickel matt; opal glass, white*

H 365, B 114, A 137

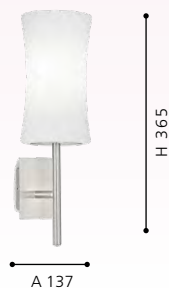
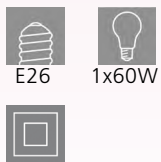

## 97887M PAUSIA

Luminario de pared de 1 luz; madera, acero, blanco pátina, níquel  
 satinado; textil, lino, gris  
*wall light; wood, steel, white-patina, satin nickel / fabric, linen, grey*

H 320, L 160

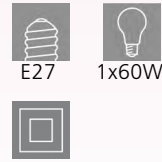



97887M

# SPOTS & LUMINARIOS DE RIEL

SPOTS & TRACKS LUMINAIRES

## ILUMINACIÓN SISTEMÁTICA

Nuestras luminarias de spots y rieles destacan lugares específicos mientras iluminan de manera óptima tus habitaciones. No importa si prefieres un aspecto moderno o tradicional, nuestra gama se adaptará a todos los gustos.

## SYSTEMATIC LIGHTING

Our spot & track luminaires set specific highlights while optimally lighting your living rooms. No matter whether you prefer a modern or a traditional look – our range will fit any taste.

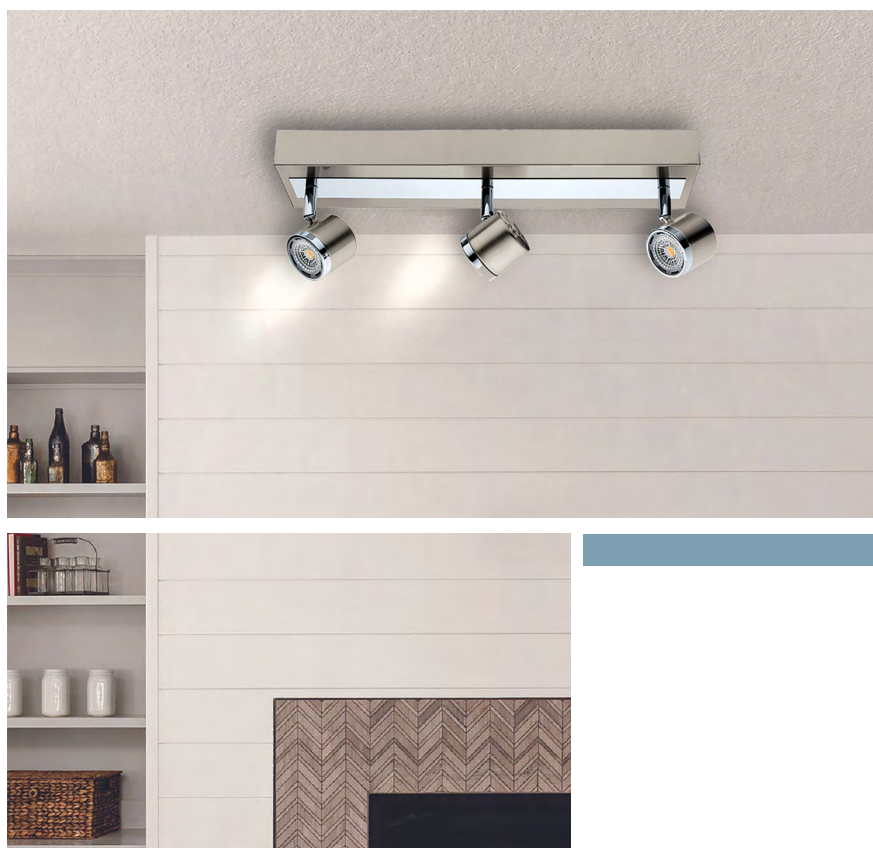

# OVERVIEW

SPOTS, TRACKS & RECESSED



JUMILLA  
p. 192



PIERINO  
p. 193



BREA  
p. 194-195



MAURICIO  
p. 196



GLENN  
p. 197



Este producto está disponible en diferentes colores y formas. / This product is available in different colors and shapes.

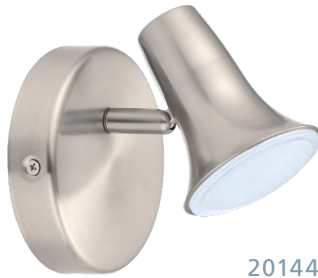

201447M



201449M



## 201447M JUMILLA

Spot LED de 1 Luz; acero, níquel mate; plástico satinado  
spot LED; steel, nickel matt; plastic white

L 117, B 115, A 123

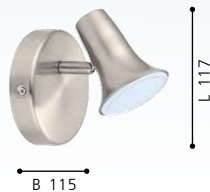

LED integrado

## 201449M JUMILLA

Spot LED de 1 Luces; acero, níquel mate; plástico satinado  
spot LED; steel, nickel matt; plastic white

L 970, B 229, H 117

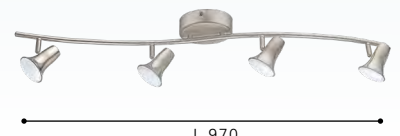

LED integrado



93693M

LED



201734M

LED

## 93693M PIERINO

Spot LED de 1 Luz; acero, níquel mate; cromo  
*spot LED; steel, nickel matt; chrome*

L 115, B 135, A 140

LED  
4,4W 440lm



LED integrado



B 135

L 115

## 201734M PIERINO

Spot LED de 3 Luces; acero, níquel mate; cromo  
*spot LED; steel, nickel matt; chrome*

L 430, B 110, H 138

LED  
3x4,4W 1320lm



LED integrado



L 430



39247M



39248M



## 39247M BREA

Luminario de pared, techo de 1 luz; aluminio, plata  
*wall & ceiling light; aluminium, silver*

L 140, B 140



LED integrado

## 39248M BREA

Luminario de pared, techo de 2 luces; aluminio,  
 plata  
*wall & ceiling light; aluminium, silver*

L 280, B 290

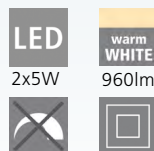

LED integrado



39133M



39134M



### 39133M BREA

Spot LED de 1 luz; acero, aluminio, white; cristal satinado, blanco, claro

spot; steel, aluminium, white; satin glass, white, clear

L 140, B 140



LED integrado

### 39134M BREA

Spot LED de 1 luces; acero, aluminio, white; cristal satinado, blanco, claro

spot; steel, aluminium, white; satin glass, white, clear

L 280, B 290



LED integrado



90723A

GL2652



GL2652

20709A

## 90723A MAURICIO

Spot de 1 luz; acero, cromo; cristal transparente, blanco  
*spot; steel, chrome; glass, clear, white*

Ø 100



G9



40W



Incluye Lámpara

## 20709A MAURICIO

Spot de 3 luces; acero, cromo; cristal transparente, blanco  
*spot; steel, chrome; glass, clear, white*

L 227



G9



3x40W



Incluye Lámpara



## 93653M GLENN

Luminario empotrable LED; metal fundido, plata; plástico, satin  
recessed light; cast metal, silver; plastic, satined

L 200, B 100, H 2, ET 85

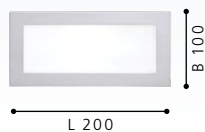
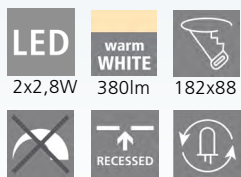

LED integrado

## 93654M GLENN

Luminario empotrable LED; metal fundido, plata; plástico, satin  
recessed light; cast metal, silver; plastic, satined

L 200, B 200, H 2, ET 105

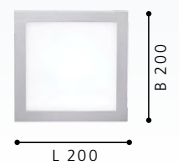
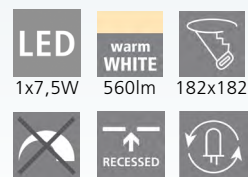

LED integrado

# LUMINARIAS DE MESA Y PIE

TABLE & FLOOR LUMINAIRES

## AMAMOS LA LUZ

La gama de luminarias de mesa y pie se compone de muchos estilos diferentes y convence con sus diversos usos. Las luminarias le dan a tu hogar un ambiente confortable y se convierten en un accesorio chic para tus habitaciones.

## OUR ALL-ROUNDERS

The range of table and floor luminaires is made up of many different styles and convinces with its diverse uses. The luminaires give your home a comfortable light mood and turn into chic living room accessories.

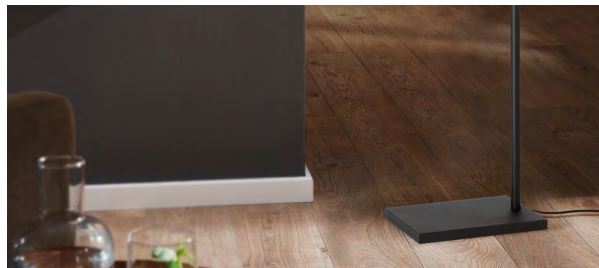



43613A

# OVERVIEW

TABLE & FLOOR LUMINAIRES



 Este producto está disponible en diferentes colores y formas. / *This product is available in different colors and shapes.*



43613A

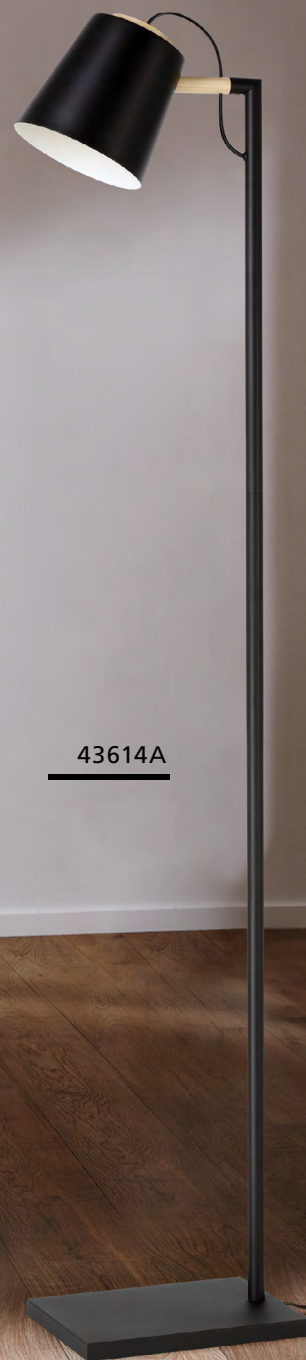

43614A

### 43613A LACEY

Luminario de mesa de 1 luz; madera natural, acero, negro  
*table light; natural wood, steel, black*

H 485, L 135, A 256



E26



1x40W



L 135

### 43614A LACEY

Luminario de pie de 1 luz; madera natural, acero, negro  
*table light; natural wood, steel, black*

H 1596, L 200, A 308



E26



1x60W



L 200



99295A

LED

TOUCH  
ME



99296A

LED

## 99295A, 99296A

Estas luminarias se pueden encender y apagar tocando la parte especialmente diseñada Touch Me del dispositivo.

*These luminaires can be switched on and off by touching the specially designed Touch Me part of the fixture..*

### 99295A CAMACHO

Luminario de mesa LED; acero, madera, negro-café, plástico blanco  
table light; steel, wood, black, brown; plastic, white

H 405, Base: B 150, T 130

LED

6,5W

warm  
WHITE

800lm



### 99296A CAMACHO

Luminario de pie LED; acero, madera, negro-café, plástico blanco  
floor light; steel, wood, black, brown; plastic, white

H 1260, Base: B 250, T 200

LED

22W

warm  
WHITE

2400lm

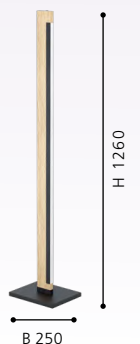

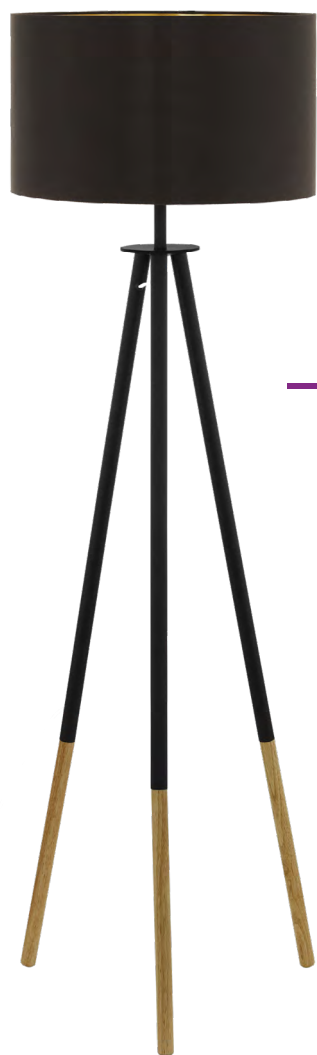

49148

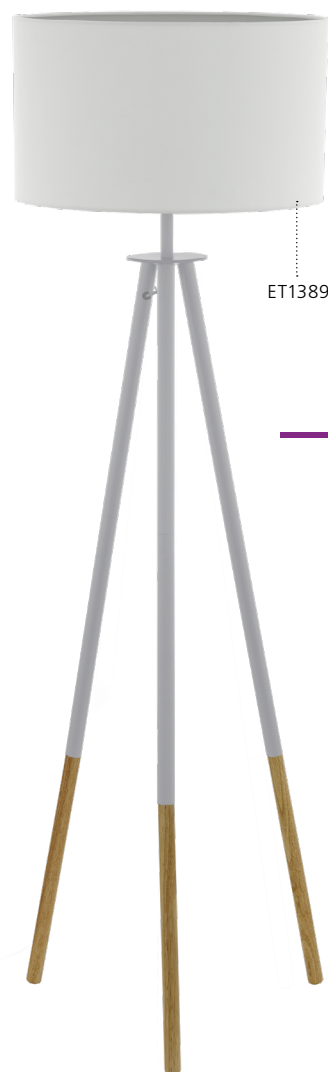

ET1389

49156

## 49148 BIDFORD

Luminario de pie de 1 luz; madera, acero, café; textil, capuchino, oro  
*floor light; wood, steel, brown; fabric, cappuccino, gold*

H 1540, Ø 460, Base: Ø 700

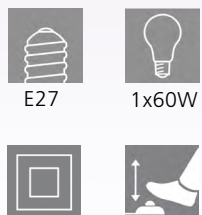

## 49156 BIDFORD

Luminario de pie de 1 luz; madera, acero, café; textil, blanco  
*floor light; wood, steel, brown; fabric, white*

H 1540, Ø 460, Base: Ø 700

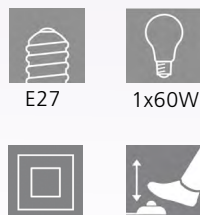

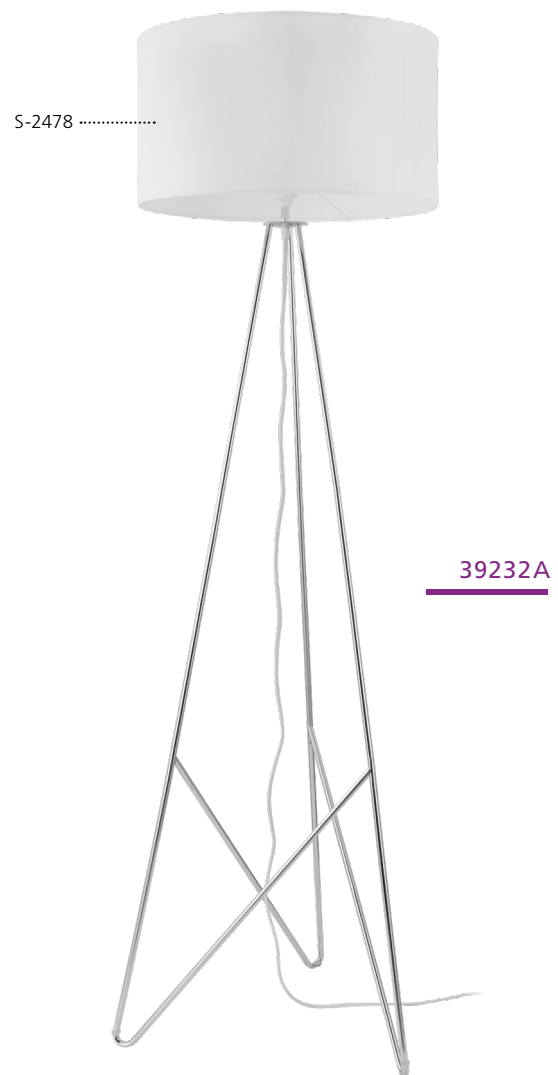

### 39181A CAMPORALE

Luminario de mesa de 1 luz; acero, cromo; textil, blanco  
*table light; steel, chrome; fabric, white*

Ø 300, H 560



E26



1x12W



### 39232A CAMPORALE

Luminario de pie de 1 luz; acero, cromo; textil, blanco  
*table light; steel, chrome; fabric, white*

Ø 450, H 1540



E26



1x12W

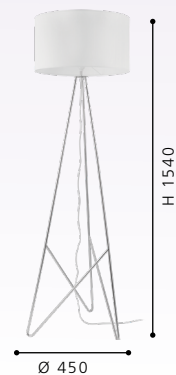

S-2572 .....



97515M

S-2549 .....



202131A



97894M

### 97515M CHIETINO

Luminario de mesa de 1 luz; madera, acero, natural, negro; textil negro, oro  
*table light; wood, steel, natural, black; fabric, black, gold*

H 440, Ø 260



E26



1x60W



H 440

Ø 260

### 202131A PEDREGAL

Luminario de mesa de 1 luz; acero, negro; textil, negro, oro  
*table light; steel, black; fabric, black, gold*

H 635, Ø 350



E26



1x60W



H 635

Ø 350

### 97894M CAMPODINO

Luminario de mesa de 1 luz; madera, arce; textil, taupé  
*table light; wood, maple; fabric, taupe*

H 500, Ø 160, Base: Ø 175



E26



1x60W

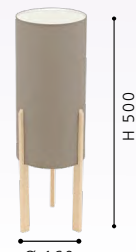

H 500

Ø 160



GL2261

GL2260

ET0900

**20597A**

**20913M**

GL1930

**20223M**

## 20597A PINTO

Luminario de mesa de 1 luz; acero, cromo; cristal claro, cristal opalino mate, blanco  
*table light; steel, chrome; glass, glass opal-matt, clear, white*

H 500, Ø 110, Base: Ø 155



E26



1x40W

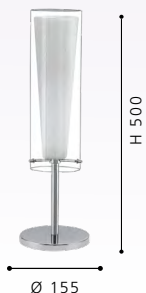

## 20913M CAVO

Luminario de mesa de 1 luz; acero, aluminio, cromo, blanco brillante  
*table light; steel, aluminium, chrome, shiny white*

H 400, B 360



G9



1x40W



## 20223M ALMERA

Luminario de mesa de 1 luz; acero, marrón antiguo, champagne  
*table light; steel, antique brown; glass, champagner*

H 295, Ø 110, Base: Ø 120



E26



1x40W





49047M

98065M

49038M

### 98065M ADRI 3

Luminario de mesa de 1 luz; acero, negro  
*table light; steel, black*

H 430, Ø 155, Base Ø 155



### 49047M CHESTER-P

Luminario de mesa de 1 luz; acero, verde pastel,  
 dorado  
*table light; steel, pastel dark green, gold*

L 290, B 290, H 440



### 49038M CHESTER-P

Luminario de mesa de 1 luz; acero,  
 albaricoque pastel, cobre  
*floor light; steel, pastel apricot, copper*

L 290, B 290, H 440

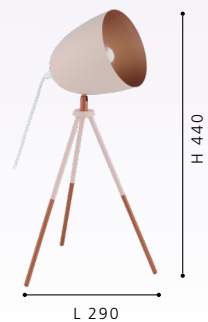

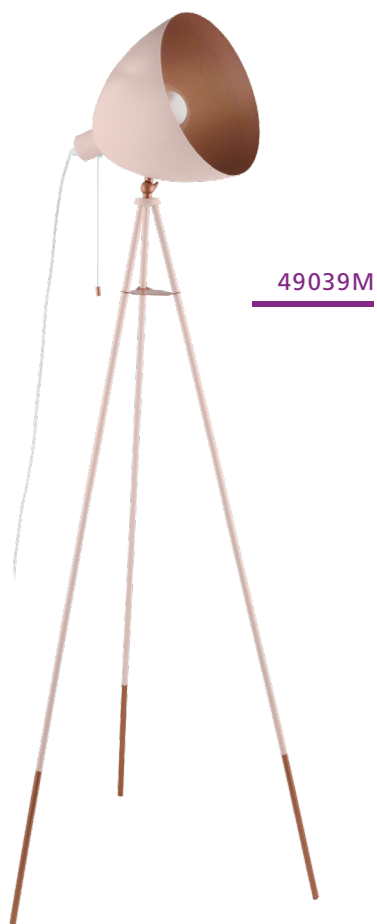

49039M



49386M

## 49039M CHESTER-P

Luminario de pie de 1 luz; acero, albaricoque pastel, cobre  
*floor light; steel, pastel apricot, copper*

L 600, B 600, H 1355



E26



1x100W

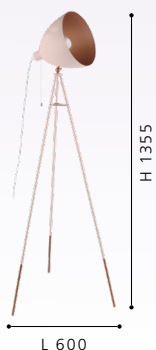

L 600

H 1355

## 49386M CHESTER

Luminario de pie de 1 luz; acero, negro, cobre  
*floor light; steel, black, copper*

L 600, B 600, H 1355



E26



1x60W



L 600

H 1355



## 97771M POLICARA

Luminario de pie; acero, níquel satinado; textil, cristal, gris pardo, blanco  
*floor light; steel, satin nickel; fabric, glass, taupe, white*

H 1630, Ø 450

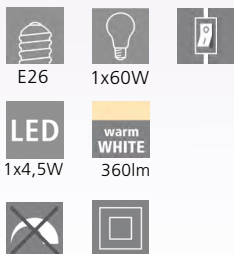

## 201828A SANTANDER

Luminario de pie; acero, níquel, textil  
*floor light; steel, nickel, fabric*

L 1530, Ø 500, B 250

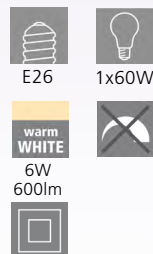

# LUMINARIAS DE BAÑO Y ESPEJO

BATH & MIRROR LUMINAIRES

## RELAJACIÓN PURA

Convierte tu baño en tu oasis de bienestar personal. Las modernas luminarias de baño y espejo proporcionan una luz agradable y garantizan la relajación y el comfort.

## PURE RELAXATION

Turn your bathroom into your personal wellness oasis. Trendy bathroom and mirror luminaires give a pleasant light and ensure relaxation and comfort.





205363A



# OVERVIEW

## BATHROOM LUMINAIRES



 Este producto está disponible en diferentes colores y formas. / *This product is available in different colors and shapes.*

# ÍNDICE DE REPRODUCCIÓN CROMÁTICA

QUALITY CRITERION / COLOUR RENDERING

## ÍNDICE DE REPRODUCCIÓN CROMÁTICA

El índice de reproducción cromática Ra describe la calidad de reproducción cromática de las lámparas. Cuanto mayor sea el valor de Ra, menos cambiará la luz artificial el color de un objeto. El valor máximo de Ra (por ejemplo, el Ra valor del sol) es 100. Por tanto, las lámparas con un Ra superior a 90 te harán lucir mejor.

Las lámparas con un valor Ra superior a 90 se marcan con este botón:

**CRI**  
**>90**

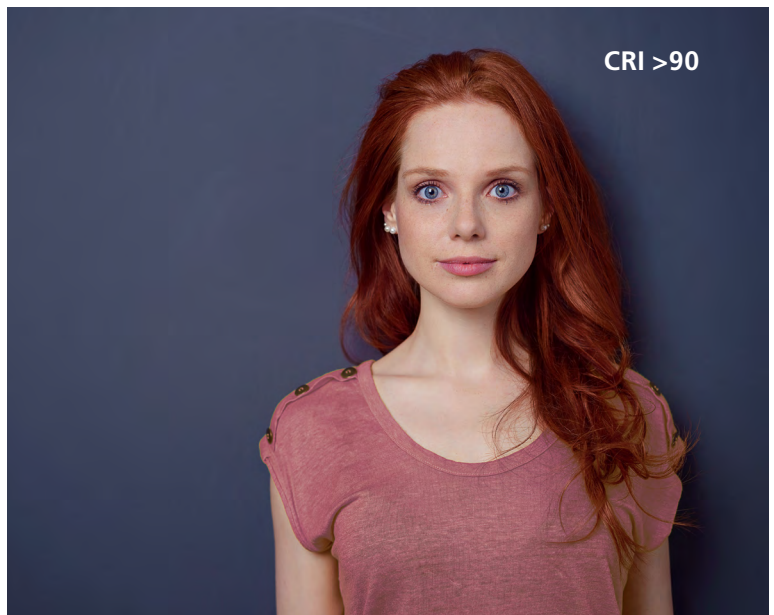

## QUALITY CRITERION COLOUR RENDERING

The colour rendering index Ra describes the colour rendering quality of lamps. The higher the Ra value, the less will the artificial light change the colour of an object. The maximum Ra value (e.g. the Ra value of the sun) is 100. Therefore, lamps with an Ra above 90 will make you look better.

Lamps with an Ra value above 90 are marked with this button:

**CRI**  
**>90**

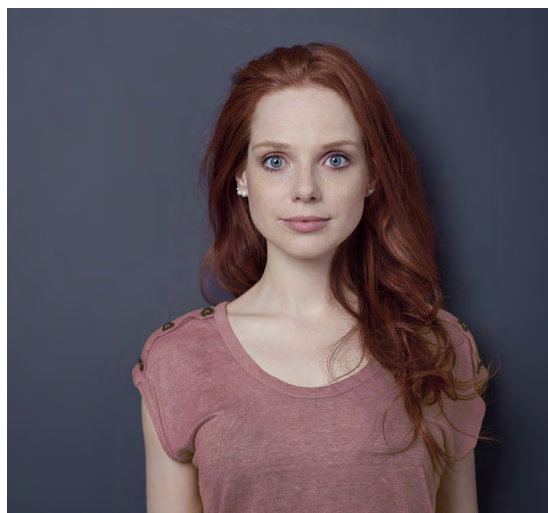



205619A

## 205619A COPLEY

Luminario de pared; acero, negro mate; vidrio claro  
*wall light; steel, matte black; clear glass*

H 233, L 640, A 212



E26



3x60W



L 640

H 233

\*Adecuado para lugares húmedos



**205621A**

## 205621A TARBES

Luminario de pared; acero, negro mate  
*wall light; steel, matte black*

H 278, L 640, A 200



E26



3x60W



\*Adecuado para lugares húmedos



205363A



205363A

## 205363A LIBERTAD

Luminario de pared; acero, madera, negro mate  
*wall light; steel, wood, matte black*

H 240, L 640, A 175



E26



3x40W



\*Adecuado para lugares húmedos



205525A



205523A



205524A



## 205525A PALMITAL

Luminario de pared; acero, níquel mate, plástico blanco  
*wall light; steel, nickel-matt, plastic white*

H 115, L 596, A 65

LED 12.7W  
 warm WHITE 1160lm



\*Adecuado para lugares húmedos

## 205523A CAMACHO

Luminario de pared; acero, cromo, plástico blanco  
*wall light; steel, chrome, plastic white*

H 140, L 674, A 73

LED 12.7W  
 warm WHITE 1160lm



\*Adecuado para lugares húmedos

## 205524A ISIDRO

Luminario de pared; acero, níquel mate, plástico blanco  
*wall light; steel, nickel-matt, plastic white*

L 584, H 115, A 71

LED 12.7W  
 warm WHITE 1160lm



\*Adecuado para lugares húmedos



204485A

LED

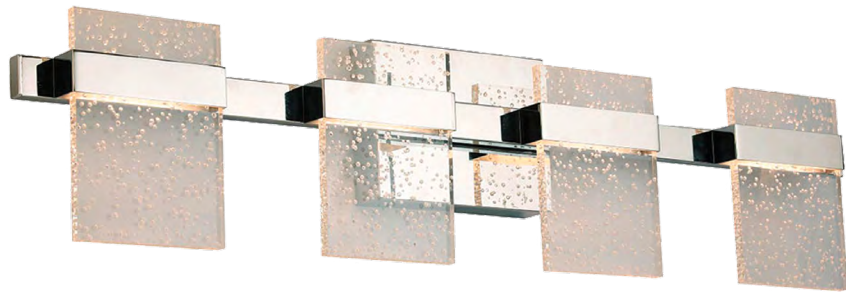

204487A

LED

## 204485A MADRONA

Luminario de pared; acero inoxidable, vidrio claro  
*wall light; stainless steel, glass clear*

L 578, H 181, A 83

LED  
 27W warm WHITE  
 1800lm

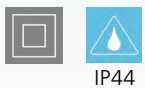

IP44



L 578

H 181

LED integrado

## 204487A MADRONA

Luminario de pared; acero inoxidable, vidrio claro  
*wall light; stainless steel, glass clear*

L 781, H 181, A 83

LED  
 31W warm WHITE  
 2400lm



IP44

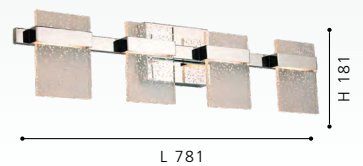

L 781

H 181

LED integrado



204485A

LED



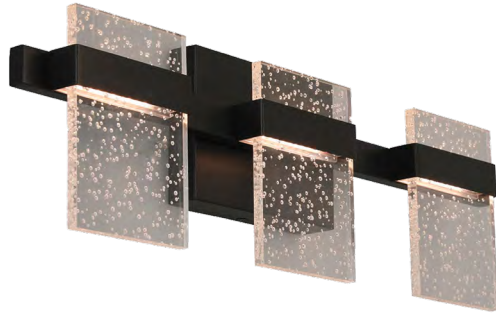

204486A

LED



204488A

LED



PB02028101

202075A

LED

## 204486A MADRONA

Luminario de pared; acero, negro, vidrio claro  
*wall light; steel, black, glass clear*

L 578, H 181, A 83

LED  
27W  
warm  
WHITE  
1800lm

IP44



L 578

LED integrado

## 204488A MADRONA

Luminario de pared; acero, negro, vidrio claro  
*wall light; steel, black, glass clear*

L 781, H 181, A 83

LED  
31W  
warm  
WHITE  
2400lm

IP44



L 781

LED integrado

## 202075A TABIANO

Luminario de pared; acero, negro, plástico blanco  
*wall light; steel, black, plastic white*

L 604, H 109, A 134

LED  
9,6W  
neutral  
WHITE  
1200lm



IP44



L 604

LED integrado



ET2135

94614M

LED



PB02028101

94613A

LED



PB02028101

94615A

LED

## 94614M TABIANO

Luminario de pared; acero, níquel mate, plástico blanco  
*wall light; steel, nickel-matt, plastic white*

L 405, H 70, A 130

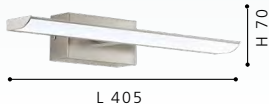

LED integrado

## 94613A TABIANO

Luminario de pared; acero, cromo, plástico blanco  
*wall light; steel, chrome, plastic white*

L 604, H 109, A 134

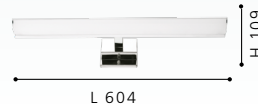

LED integrado

## 94615A TABIANO

Luminario de pared; acero, níquel mate, plástico blanco  
*wall light; steel, nickel-matt, plastic white*

L 604, H 109, A 134



LED integrado



204374A

LED



204375A

LED



204374A

LED

## 204375A PALMERA 1

Luminario de pared; acero, oro cepillado; vidrio blanco  
*wall light; steel, brushed gold; glass white*

L 125, H 270, A 130



LED integrado

## 204374A PALMERA 1

Luminario de pared; acero, oro cepillado; vidrio blanco  
*wall light; steel, brushed gold; glass white*

L 125, H 434, A 130



LED integrado



204373A



204372A



204372A



## 204373A PALMERA 1

Luminario de pared; acero, negro, vidrio blanco  
wall light; steel, black, glass white

L 125, H 270, A 130



LED integrado

## 204372A PALMERA 1

Luminario de pared; acero, negro, vidrio blanco  
wall light; steel, black, glass white

L 125, H 434, A 130

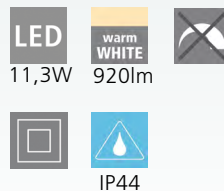

LED integrado



95143M

LED

GL3484



95144M

LED



GL1755

88284M

LED

## 95143M PALMERA 1

Luminario de pared; acero, níquel satinado; cristal opalino, blanco  
*wall light; steel, satin nickel; opal glass, white*

L 125, B 270, A 115



LED integrado

## 95144M PALMERA 1

Luminario de pared; acero, níquel satinado; cristal opalino, blanco  
*wall light; steel, satin nickel; opal glass, white*

L 435, B 125, A 125

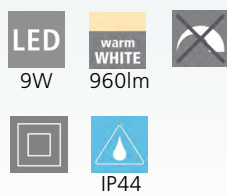

LED integrado

## 88284M PALERMO

Luminario de pared; acero, níquel satinado; cristal opalino, blanco  
*wall light; steel, satin nickel; opal glass, white*

L 95, H 330, A 115

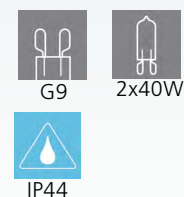

Incluye lámpara



### 202363A MIERE

Luminario de pared; acero, níquel satinado, cristal satinado, blanco  
*wall light; steel, satin nickel; satinated glass, white*

L 350, H 50, A 85

**LED** warm WHITE  
 8W 770lm

IP44

**CRI >90**

LED integrado



### 202364A MIERE

Luminario de pared; acero, níquel satinado, cristal satinado, blanco  
*wall light; steel, satin nickel; satinated glass, white*

L 600, H 50, A 85

**LED** warm WHITE  
 16W 1500lm

IP44

**CRI >90**

LED integrado



### 202365A MIERE

Luminario de pared; acero, níquel satinado, cristal satinado, blanco  
*wall light; steel, satin nickel; satinated glass, white*

L 900, H 50, A 85

**LED** warm WHITE  
 24W 2200lm

IP44

**CRI >90**

LED integrado



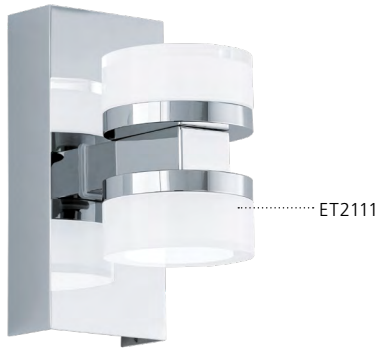

94651A

LED

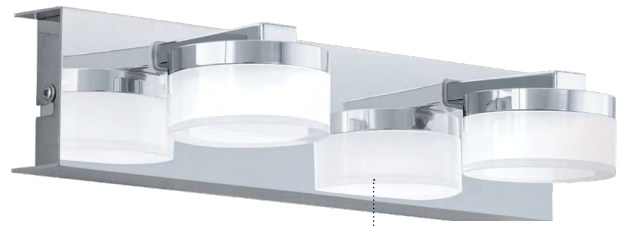

ET2111

94652A

LED



ET2111

94654A

LED

## 94651A ROMENDO

Luminario de pared de 2 luces; acero, cromo; plástico, transparente, satin  
*wall light; steel, chrome; plastic, clear, satinated*

L 70, H 155, A 120

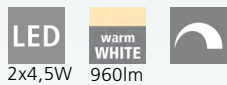

LED integrado

## 94652A ROMENDO

Luminario de pared de 2 luces; acero, cromo; plástico, transparente, satin  
*wall light; steel, chrome; plastic, clear, satinated*

L 300, H 70, A 125

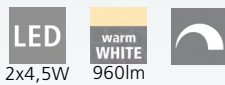

LED integrado

## 94654A ROMENDO

Luminario de pared de 5 luces; acero, cromo; plástico, transparente, satin  
*wall light; steel, chrome; plastic, clear, satinated*

L 320, H 320, A 70

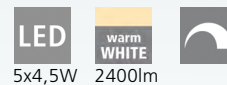

LED integrado



Estas luminarias son dimeables.

*These luminaires are dimmable.*

## 94653A ROMENDO

Luminario de pared de 3 luces; acero, cromo;  
plástico, transparente, satin  
*wall light; steel, chrome; plastic, clear, satinated*

L 450, H 70, A 125



3x4,5W 1440lm



IP44

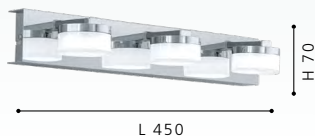

LED integrado

94653A

LED





97699M

## 97699M ALMONTE

Luminario de techo de 8 luces; acero, cromo; cristal, transparente  
*ceiling light; steel, chrome; crystal, clear*

H 300, Ø 500



G9



8x3W



INCL.

Ø 500



IP44



Incluye Lámpara



## 97609M LORETTO

Luminario de pared de 1 luz; acero, cromo; cristal, blanco, transparente

*wall light; steel, chrome; glass, crystal, white, clear*

L 145, H 310, A 200



Incluye Lámpara

## 97429M FRISCOLI

Luminario de pared de 1 luz; acero, cromo; cristal opalino, blanco

*wall light; steel, chrome; opal glass, white*

L 145, H 270, A 175



Incluye Lámpara



33682M

LED



97754M

LED

ET2594

## 33682M LED CARPI

Luminario de techo; acero, negro, blanco, plástico blanco  
*wall light; steel, black, white; plastic white*

H 75, Ø 300

LED 12W  
warm WHITE 1077lm



IP44



Ø 300

LED integrado

## 97754M COMPETA 1

Luminario de techo, techo; acero, blanco; plástico, blanco, cromo  
*wall & ceiling light; steel, white; plastic, white, chrome*

H 85, Ø 345

LED 16W  
WW+NW  
100% 2700K = 1400lm  
100% 4000K = 1600lm



IP44



Ø 345

LED integrado



GL3598

97531M



## 97531M

Esta luminaria viene con un sensor de movimiento integrado. El sensor está montado de forma invisible detrás del cristal.

*This luminaire comes with an integrated motion sensor. The sensor is mounted invisibly behind the glass.*



97531M



## 97531M BARI-M

Luminario de techo; plástico, blanco,  
cristal, blanco  
*ceiling light; plastic, white; glass, white*

H 110, Ø 275



E26



20W



IP44



Ø 275



### 85337M MONO

Luminario de pared de 1 luz; acero, cromo; cristal satinado, blanco  
*wall light; steel, chrome; satinated glass, white*

L 245, B 70, A 65

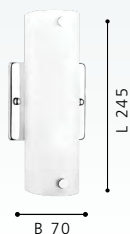
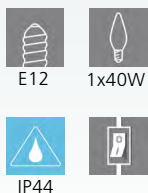

### 85338M MONO

Luminario de pared de 2 luces; acero, cromo; cristal satinado, blanco  
*wall light; steel, chrome; satinated glass, white*

L 340, B 70, H 65



### 85339M MONO

Luminario de pared de 3 luces; acero, cromo; cristal satinado, blanco  
*wall light; steel, chrome; satinated glass, white*

L 590, B 70, H 65

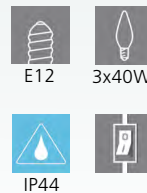



GL-309

**80283M**



**20994M**

## 80283M BARI

Luminario de pared de 2 luces; acero, cromo;  
cristal satinado, blanco  
*wall light; steel, chrome; satinated  
glass, white*

L 420, B 300



## 20994M DOREEN

Luminario de espejo; acero, cromo  
*mirror light; steel, chrome*

L 355, H 146, A 130

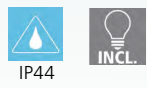

Incluye Lámpara

# LUMINARIAS DE EXTERIOR

## OUTDOOR LUMINAIRES

### MODERNO, SEGURO Y CONFORTABLE

Un diseño minimalista y de líneas rectas asegura un toque moderno. Las luminarias fabricadas en acero inoxidable, aluminio o acero, combinadas con elementos de vidrio refinado, harán que su espacio exterior brille con una luz moderna y atemporal.

### MODERN, SAFETY & COMFORT

A straight-lined and minimalist design ensures a modern touch. The luminaires made of stainless steel, aluminium or steel, combined with refined glass elements, will make your outdoor area shine in a modern and yet timeless light.







































900136

# OVERVIEW

## OUTDOOR LUMINAIRES

					
FANDINA p. 239	SERRICELLA p. 239	KIBEA p. 240	PREDAZZO p. 241	BOSARO p. 242	CULPINA p. 243
					
PARDELA p. 243	MADRONA p. 244	DONINNI p. 245	NOCELLA p. 246	CALDIERO p. 247	BUDRONE p. 248
					
CARRARO p. 248	ABNER p. 249	BRANDEL p. 250	MELGOA p. 250	SIRMIONE p. 251	PRATA VECCHIA p. 251
					
ALAMONTE 3 p. 252	ALAMONTE 1 p. 253	RIGA 5 p. 254	RIGA 1 p. 255-256	ASCOLI 1 p. 257	ZIMBA p. 258
					
VENTO p. 258	ARKTIC p. 258	DODO p. 259	BOND p. 259	HILBURN 1 p. 260	MOUNA p. 260
					
ZIMBA LED p. 261-262	LADUNARA p. 264	FOSSOMBRONE p. 264			

 Este producto está disponible en diferentes colores y formas./ *This product is available in different colors and shapes.*

# La mejor protección contra el clima



La gama de productos de clase IP alta de EGLO incluye todas las luminarias con un grado de protección particularmente alto. Estos son los más adecuados para entornos hostiles como las regiones arenosas o costeras.

¡Todas las luces exteriores EGLO están básicamente aseguradas con al menos un grado de protección de IP44! Para grados superiores, el grado de protección se indica en el cuadro de información de las luminarias.

EGLO's High IP class product range includes all luminaires with a particularly high degree of protection. These are best suited for harsh environments such as sandy or coastal regions.

All EGLO outdoor lights are basically secured with at least a degree of protection of IP44! For higher degrees, the degree of protection is indicated in the info box of the lights.

## SOLIDOS / SOLIDS

0	Sin protección. Non protected.
1	Protegido contra un objeto sólido de más de 50 mm, como una mano. Protected against a solid object greater than 50mm, such as a hand.
2	Protegido contra un objeto sólido de más de 12 mm, como un dedo. Protected against a solid object greater than 12mm, such as a finger.
3	Protegido contra un objeto sólido de más de 2,5 mm, como un destornillador. Protected against a solid object greater than 2,5mm, such as a screw driver.
4	Protegido contra un objeto sólido de más de 1 mm, como un tornillo o un cable. Protected against a solid object greater than 1mm, such as a screw or wire.
5	Protegido contra el polvo. Evita la entrada de polvo suficiente para causar daño. Dust protected. Prevents ingress of dust sufficient to cause harm.
6	A prueba de polvo. Sin entrada de polvo. Dust tight. No ingress of dust.

## AGUA / WATER

0	Sin protección. Non protected.
1	Protegido contra el goteo vertical de agua. Entrada limitada de líquidos. Protected against vertical dripping water. Limited liquid entry.
2	Protegido contra el goteo vertical de agua cuando se inclina hacia arriba 15°. Entrada limitada de líquidos. Protected against vertical dripping water when tilted up 15°. Limited liquid entry.
3	Protegido contra salpicaduras de agua verticales en un ángulo de hasta 68°. Entrada limitada de líquidos. Protected against vertical spraying water at an angle up to 68°. Limited liquid entry.
4	Protegido contra salpicaduras de agua verticales en un ángulo de hasta 60°. Entrada limitada de líquidos. Protected against vertical splashing water at an angle up to 60°. Limited liquid entry.
5	Protegido contra chorros de agua desde todas las direcciones. Entrada limitada de líquidos. Protected against jets of water from all directions. Limited liquid entry.
6	Protegido contra potentes chorros de agua desde todas las direcciones. Entrada limitada de líquidos. Protected against powerful jets of water from all directions. Limited liquid entry.
7	Protegido contra los efectos de la inmersión en agua entre 15cm y 1m. Protected against the effects of water immersion between 15cm and 1m.
8	Protegido contra los efectos de la inmersión en agua bajo presión más allá de 1 m. Protected against the effects of water immersion under pressure beyond 1m.

**IP65**

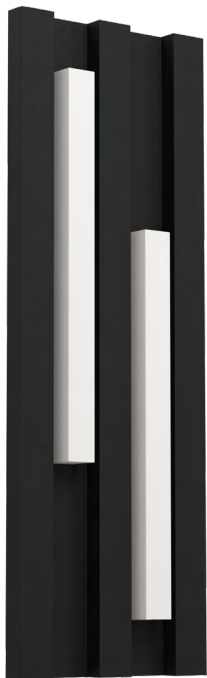

900118



900119



900133



## 900118 FANDINA

Luminario de pared; acero cincado, negro; plástico, blanco  
*wall light; zinc-plated steel, black; plastic, white*

L 145, H 415, A 55



LED integrado

## 900119 FANDINA

Luminario de pared; acero cincado, blanco; plástico, blanco  
*wall light; zinc-plated steel, white; plastic, white*

L 145, H 415, A 55

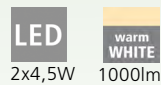

LED integrado

## 900133 SERRICELLA

Luminario de pared; acero cincado, negro; plástico, blanco  
*wall light; zinc-plated steel, black; plastic, white*

L 100, H 495, A 60

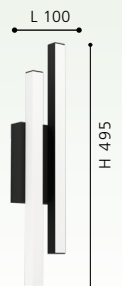

LED integrado

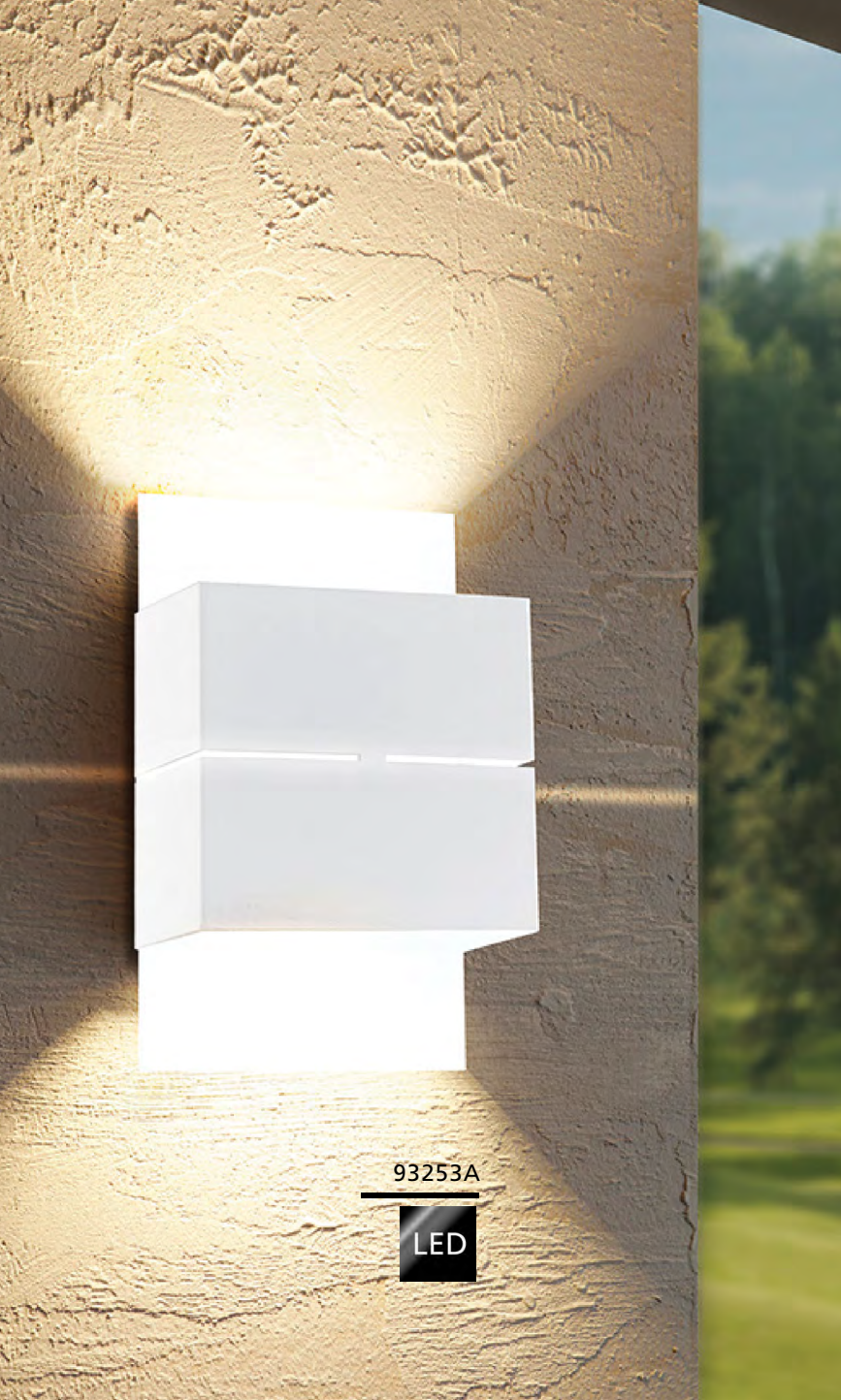

93253A

LED



200886A

LED

## 93253A KIBEA

Luminario de pared; acero galvanizado, blanco  
*wall light; galvanized steel, white*

L 150, H 260, A 75

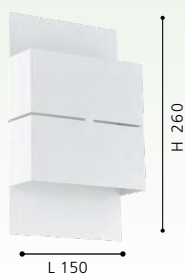

## 200886A KIBEA

Luminario de pared; acero galvanizado, negro  
*wall light; galvanized steel, black*

L 150, H 260, A 75





203454A

LED



203455A

LED

## 203454A PREDAZZO

Luminario de pared; acero galvanizado, negro, blanco  
*wall light; galvanized steel, black, white*

L 140, H 210, A 96



## 203455A PREDAZZO

Luminario de pared; acero galvanizado, blanco  
*wall light; galvanized steel, white*

L 140, H 210, A 96





93991M

LED

## 93991M BOSARO

Luminario de pared; acero cincado, blanco  
*wall light; zinc-plated steel, white*

L 170, H 270, A 105





98087M

LED



98088M

LED



200837M

LED

98087M, 98088M, 200837M

Letras y números incluidos en la entrega.

Letters and numbers included in delivery.

### 98087M CULPINA

Luminario de pared LED; aluminio, blanco, plástico blanco

wall light; aluminium, white, plastic, white

L 190, H 270, A 80

LED  
10W  
warm  
WHITE  
960lm



IP44



H 270

L 190

### 98088M CULPINA

Luminario de pared LED; aluminio, antracita, plástico blanco

wall light; aluminium, anthracite, plastic, white

L 190, H 270, A 80

LED  
10W  
warm  
WHITE  
960lm



IP44



H 270

L 190

### 200837M PARDELA

Luminario de pared LED; acero inoxidable

wall light; stainless steel

L 170, H 280, A 100

LED  
2,8W  
warm  
WHITE  
160lm



IP44



H 280

L 170

LED integrado

LED integrado

LED integrado



204482A



204481A



## 204482A MADRONA

Luminario de pared LED; acero, negro, vidrio claro  
*wall light; steel, black, glass clear*

B 127, H 181, A 60

LED  
10W

warm  
WHITE  
600lm



IP44



H 181

B 127

## 204481A MADRONA

Luminario de pared LED; acero inoxidable, vidrio claro  
*wall light; stainless steel, glass clear*

B 127, H 181, A 60

LED  
10W

warm  
WHITE  
600lm



IP44



H 181

B 127



202637A

LED



202638A

LED

## 202637A DONINNI

Luminario de pie; aluminio, negro, plástico transparente  
*floor light; aluminium, black, plastic transparent*

L 135, B 75, H 400



## 202638A DONINNI

Luminario de pie; aluminio, negro, plástico transparente  
*floor light; aluminium, black, plastic transparent*

L 135, B 75, H 800

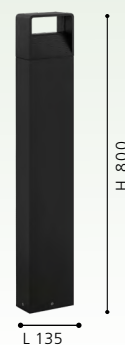



94141M



94139M



## 94141M NOCELLA

Luminario de pared; aluminio, antracita, plástico blanco  
*wall light; aluminium, anthracite, plastic white*

A 210, H 110, B 175

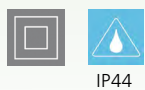

A 210

LED integrado

## 94139M NOCELLA

Luminario de pared; aluminio, plata; plástico, blanco  
*wall light; aluminium, silver; plastic, white*

A 210, H 110, B 175



A 210

LED integrado



**97146M**



**97452M**

## 97146M CALDIERO

Luminario de pared; acero zincado, antracita, plástico, blanco  
*wall light; zinc-plated, anthracite, plastic, white*

L 140, H 240, A 185



E26



1x60W



IP44



## 97452M CALDIERO

Luminario de pared; acero inoxidable, plástico, blanco  
*wall light; stainless steel, plastic, white*

L 140, H 240, A 185



E26



1x60W



IP44





900289



900286



900289

Esta luminaria se puede montar hacia arriba o hacia abajo.  
*This luminaire can be mounted upwards or downwards.*

## 900289 BUDRONE

Luminario de pared; acero, madera, negro, marrón; vidrio, claro  
*wall light; steel, wood, black, brown; glass, clear*

L 120, H 270, A 165



E27



1x40W



IP44



## 900286 CARRARO

Luminario de pared; acero, gris, negro; vidrio, transparente  
*wall light; steel, grey, black; glass, clear*

L 115, H 380, A 130



E27



1x40W



IP44





204559A



204558A

## 204558A ABNER

Luminario de pared de 1 luz; acero, negro, vidrio con burbujas de aire, claro

*wall light; steel, black, glass with bubbles, clear*

B 190, H 343, A 229

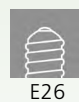



204544A



204545A



.....GL3396

94863M

## 204544A BRANDEL

Luminario de pared de 1 luz; acero, color óxido, vidrio con burbujas de aire, claro  
*wall light; steel, rust-colored, glass with bubbles, clear*

B 171, H 330, A 206

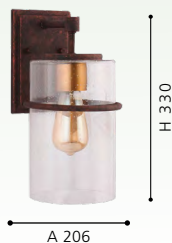
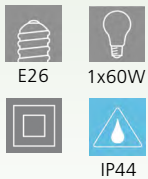

## 204545A BRANDEL

Luminario de pared de 1 luz; acero, color óxido, vidrio con burbujas de aire, claro  
*wall light; steel, rust-colored, glass with bubbles, clear*

B 206, H 374, A 235

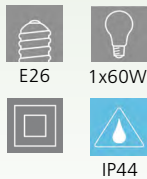

## 94863M MELGOA

Luminario de pared; acero cincado, color cobre antiguo; vidrio, transparente  
*wall light; zinc-plated steel, copper-coloured antique; glass, clear*

L 300, H 250, A 380

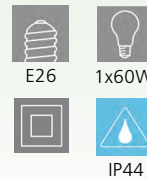



## 97285M SIRMIONE

Luminario de pared; acero cincado, negro, dorado: vidrio opalino mate, blanco  
*wall light; zinc-plated steel, black, gold: glass opal-matt, white*

L 270, H 375, A 330

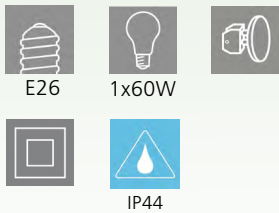

## 98731 PRATA VECCHIA

Luminario de pared; acero cincado, negro; plástico, blanco  
*wall light; zinc-plated steel, black; plastic, white*

L 200, H 260, A 285

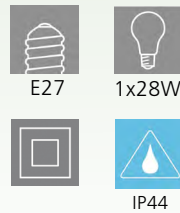



900136



900136

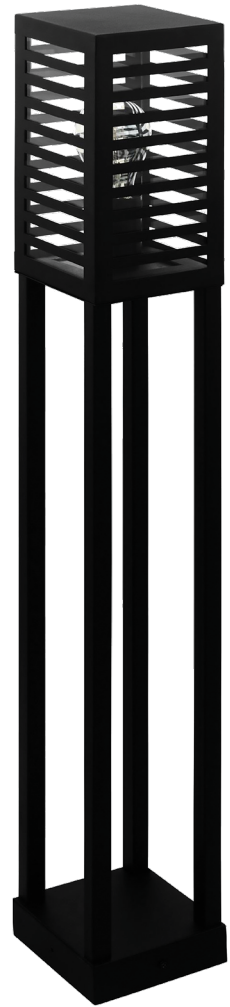

900139

## 900136 ALAMONTE 3

Luminario de pared; aluminio, acero, negro  
wall light; aluminium, steel, black

L 170, H 260, A 100



E27



1x60W



IP44

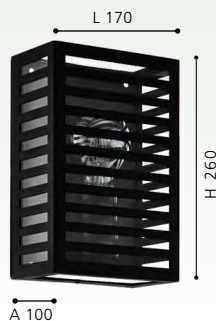

E27



1x60W



IP44



## 900139 ALAMONTE 3

Luminario de piso; aluminio, acero, negro  
floor light; aluminium, steel, black

L 150, B 150, H 1000



94788M



98273M



94789M

## 94788M ALAMONTE 1 98273M ALAMONTE 1 94789M ALAMONTE 1

Luminario colgante 1 luz; acero zincado, negro, vidrio, transparente  
*pendant light; zinc-plated steel, black, glass, clear*

L 150, B 150, H 1285

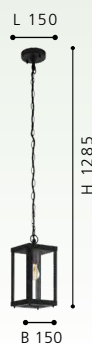
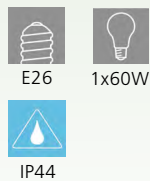

Luminario de pared/techo 2 luces; acero zincado, negro, vidrio, transparente  
*wall & ceiling light; zinc-plated steel, black, glass, clear*

B 150, H 380, A 100

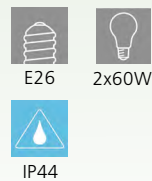

Luminario de mesa de 1 luz; acero zincado, negro, vidrio, transparente  
*table light; zinc-plated steel, black, glass, clear*

B 150, L 150, H 275

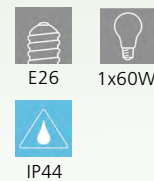



100°, 6 m  
10 sec. - 12 min.

32898M

LED

**SAFETY &  
COMFORT**



100°, 6 m  
10 sec. - 12 min.

32899M

LED

**SAFETY &  
COMFORT**

## 32898M RIGA 5

Luminario de pared; acero inoxidable, cristal, claro  
*wall light; stainless steel, glass, clear*

L 65, H 215, A 110

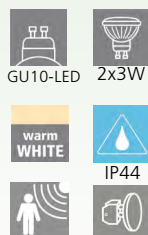

Incluye Lámpara



## 32899M RIGA 5

Luminario de pared; acero zincado, antracita, cristal, claro  
*wall light; zinc-plated, steel, anthracite, glass, clear*

L 65, H 215, A 110

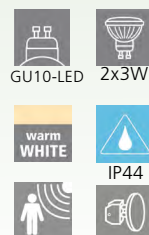

Incluye Lámpara





200033A

GL1208



200032A

GL1208



84002M

GL1208

### 200032A RIGA 1

Luminario de pared de 1 luz; acero, negro, cristal, claro  
*wall light; steel, black; glass, clear*

L 65, H 150, A 95



### 200033A RIGA 1

Luminario de pared de 2 luces; acero, negro, cristal, claro  
*wall light; steel, black; glass, clear*

L 65, H 200, A 95



### 84002M RIGA 1

Luminario de pared de 2 luces; acero, satin  
*wall light; steel, satined*

L 65, H 200, A 95



Incluye Lámpara



84001M

GL1208



84004M

GL1208

## 84001M RIGA 1

Luminario de pared de 1 luz; acero, blanco  
*wall light; steel, white*

L 65, H 150, A 95



Incluye Lámpara



A 95

## 84004M RIGA 1

Luminario de pared de 2 luces; acero, blanco  
*wall light; steel, white*

L 65, H 200, A 95



Incluye Lámpara



A 95



200022A



200023A

## 200022A ASCOLI 1

Luminario de pared de 1 luz; acero, negro, cristal, claro  
*wall light; steel, black; glass, clear*

L 125, H 220, A 160



E26



60W



IP44



A 160

## 200023A ASCOLI 1

Luminario de pared de 2 luces; acero, negro, cristal, claro  
*wall light; steel, black; glass, clear*

L 125, H 325, A 160



E26



2x60W



A 160



**20897M**



**86993M**



GL1611

**88052M**

## 20897M ZIMBA

Luminario empotrable; aluminio fundido, plata; cristal satinado, blanco  
*recessed light; cast aluminium, silver; satin glass, white*

L 243, B 101, H 5, ET 100



E26



1x60W



IP44



234x87



RECESSED

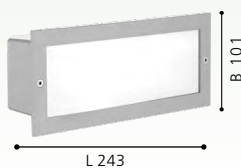

L 243

B 101

## 88052M VENTO

Luminario de pared de 2 luces; acero inoxidable, cristal  
*wall light; stainless steel, glass*

Ø 283, A 80



G9



2x40W



IP44



Ø 283

Incluye Lámpara

## 86993M ARKTIC

Luminario de pared de 1 luz; acero inoxidable, cristal  
*wall light; stainless steel, glass*

L 180, H 237, A 105



E26



1x100W



IP44

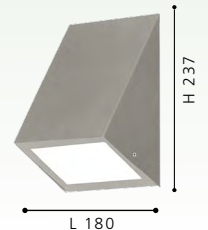

L 180

H 237



## 20889M DODO

Luminario de pared de 1 luz; acero, plástico  
*wall light; steel, plastic*

L 160, H 447

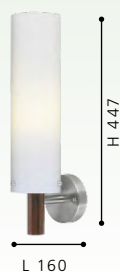

## 90166 BOND

Luminario de pared de 1 luz; acero, cristal  
*wall light; steel, glass*

H 340, Ø 180, A 250



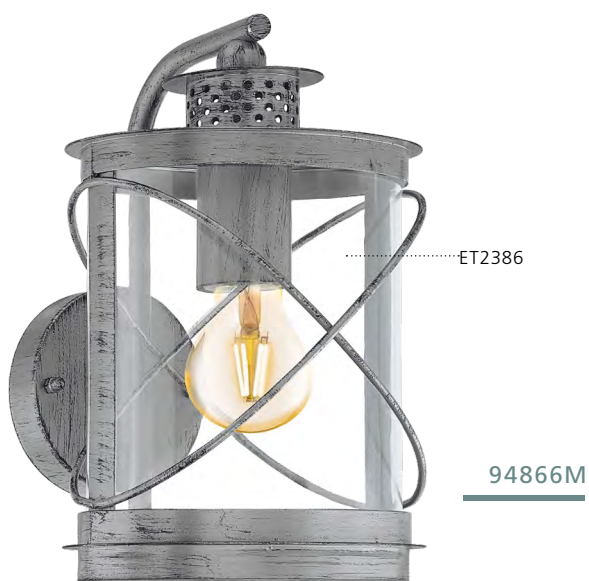

ET2386

94866M



20663M

## 94866M HILBURN 1

Luminario de pared; acero galvanizado, plata antigua; plástico, transparente  
*wall luminaire; galvanized steel, antique silver; plastic, transparent*

L 200, H 280, A 200



E26

1x60W



IP44

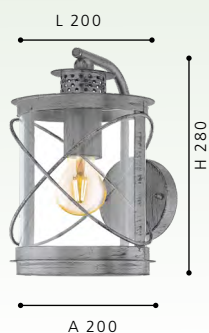

L 200

H 280

A 200



E26

1x60W



IP44

## 20663M MOUNA

Luminario de pared de 1 luz; acero, plástico  
*wall light; steel, plastic*

B 117, A 165, H 390



H 390

A 165



89543M



89544M



### 89543M ZIMBA LED

Luminario empotrable; aluminio fundido, plata  
recessed light; cast aluminium, silver

H 5, Ø 125, ET 95



### 89544M ZIMBA LED

Luminario empotrable; aluminio fundido, plata  
recessed light; cast aluminium, silver

L 235, B 185, H 5, ET 95

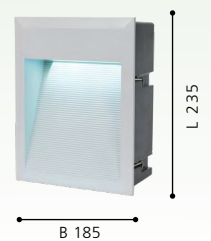
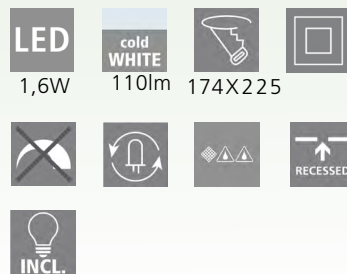



89545M



89546M



## 89545M ZIMBA LED

Luminario empotrable; aluminio fundido, plata  
*recessed light; cast aluminium, silver*

L 140, B 140, H 5, ET 95

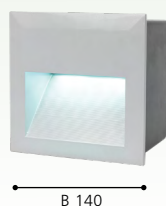

## 89546M ZIMBA LED

\*Luminario empotrable; aluminio fundido, plata  
*recessed light; cast aluminium, silver*

L 140, B 140, H 5, ET 95

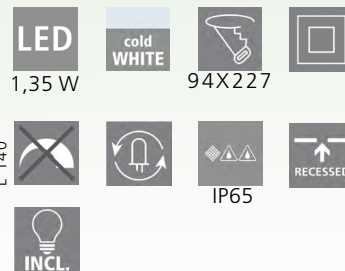

# GARDEN LIVING

## LUMINARIAS DE JARDIN

### AMBIENTE EXTERIOR

Si la sala de estar al aire libre se va a convertir un oasis de bienestar, la iluminación adecuada no debe faltar. Los productos de la gama Garden Living crea la atmósfera correcta. Acogedoras lámparas de mesa y de pie, transformarán cada jardín en un punto de atracción único que le invita a quedarse y relajarse al aire libre en las cálidas tardes de verano.

### OUTDOOR ATMOSPHERE

If the outdoor living room is to become an oasis of well-being, the right lighting must not be missing. The products from the Garden Living range create the right atmosphere. Cosy table and floor lamps transform every garden into a unique eye-catcher that invites you to linger and relax in the open air on warm summer evenings.

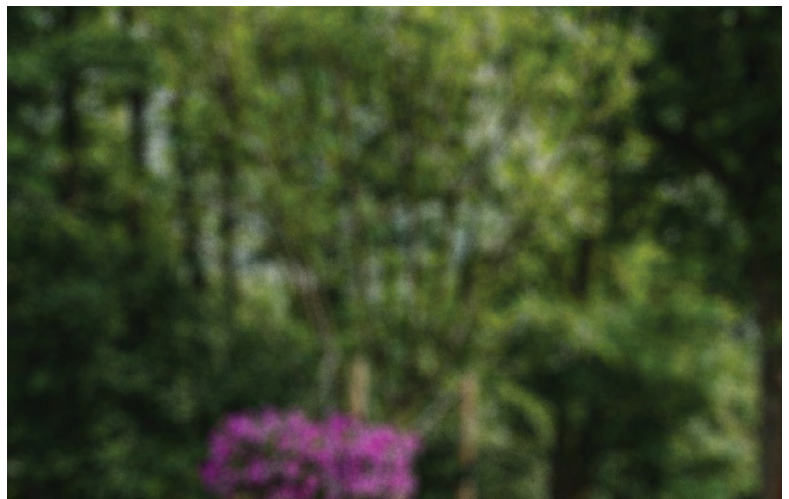



900259

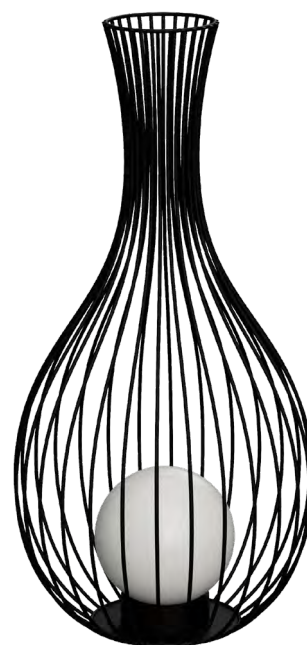

900122



## 900259 LADUNARA

Luminario de piso; acero, negro  
*floor light; steel, black*

H 1115, Ø 250, Base: B 700, T 700



## 900122 FOSSOMBRONE

Luminario de piso; acero cincado, negro; plástico, blanco  
*floor light; zinc-plated steel, black; plastic, white*

H 685, Ø 320, Base: Ø 230

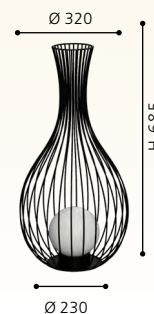



900122

# EGLO LIGHT

## EGLO LIGHT

### ENSAMBLADO EN MEXICO

Nuestra línea EGLO Light es sinónimo de calidad y diseño al alcance de todos. Año tras año continuamos con nuestro compromiso de mantener nuestros estándares de calidad. Agradecemos su preferencia y apoyo en éste proyecto orgullosamente mexicano.

### ASSEMBLED IN MEXICO

Our EGLO Light line is synonymous of quality and design available to everyone. Year after year we continue with our commitment to maintain our quality standards. we appreciate your preference and support in this proudly mexican project.





90151M



GL3900

98023M



MT1862

GL-598

MT1863

89324M

## 98023M MONTENOVO

Luminario techo, pared; acero, blanco; vidrio, blanco, oro  
*wall / ceiling light; steel, white; glass, white, gold*

H 100, Ø 395

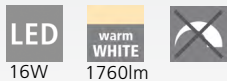

## 89324M TOLEDA

Luminario techo, pared; acero, blanco, cristal satinado, metal, blanco, café, naranja  
*wall, ceiling light; steel, white, satinated glass, metal, white, brown, orange*

L 410, H 410, A 98

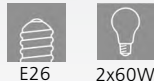

Ø 400

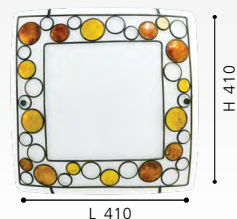



98023M



## SALOME

Estas luminarias vienen con vidrio de alabastro procesado de alta calidad

*These luminaires come with high quality processed alabaster glass.*

### 7183M SALOME

Luminario techo, pared; acero, níquel satinado; cristal alabastro, blanco  
*wall, ceiling light; steel, nickel satined, alabaster glass, white*

Ø 400, A 110



E26



2x60W



Ø 400

### 7187M SALOME

Luminario pared; acero, níquel satinado; cristal alabastro, blanco  
*wall light; steel, nickel satined, alabaster glass, white*

L 300, H 150, A 90



E26



1x60W



Ø 300

H 150

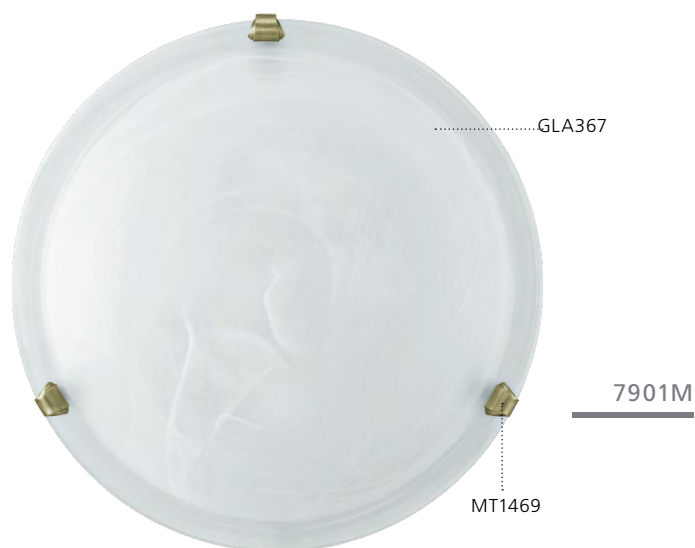

## 7901M SALOME

Luminario techo, pared; acero, bronce; cristal satinado, blanco

*wall, ceiling light; steel, bronzed, alabaster glass, white*

Ø 400, A 110



## 7902M SALOME

Luminario techo, pared; acero, bronce; cristal satinado, blanco

*wall, ceiling light; steel, bronzed, alabaster glass, white*

Ø 300, A 110



## 7903M SALOME

Luminario pared; acero, bronce; cristal satinado, blanco

*wall light; steel, bronzed, alabaster glass, white*

L 300, H 150, A 90

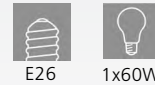



## 7184M SALOME

Luminario techo, pared; acero, cromo; cristal satinado, blanco

*wall, ceiling light; steel, chrome, alabaster glass, white*

Ø 400, A 110



E26



2x60W



Ø 400

## 7186M SALOME

Luminario techo, pared; acero, cromo; cristal satinado, blanco

*wall, ceiling light; steel, chrome, alabaster glass, white*

Ø 300, A 110



E26



1x60W



Ø 300

## 7188M SALOME

Luminario pared; acero, cromo; cristal satinado, blanco

*wall light; steel, chrome, alabaster glass, white*

L 300, H 150, A 90



E26



1x60W



L 300

H 150

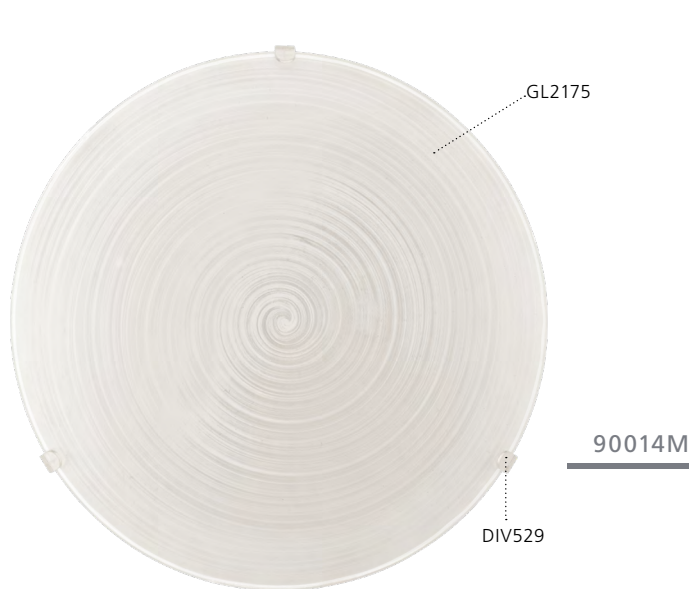

## 90014M MALVA

Luminario techo, pared; acero, blanco; cristal satinado, blanco  
*wall, ceiling light; steel, white, satinated glass, beige*  
 Ø 395, A 95



## 90015M MALVA

Luminario techo, pared; acero, blanco; cristal satinado, blanco  
*wall, ceiling light; steel, white, satinated glass, beige*  
 Ø 315, A 95

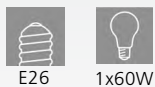

## 90016M MALVA

Luminario techo, pared; acero, blanco; cristal satinado, blanco  
*wall, ceiling light; steel, white, satinated glass, beige*  
 Ø 250, A 75



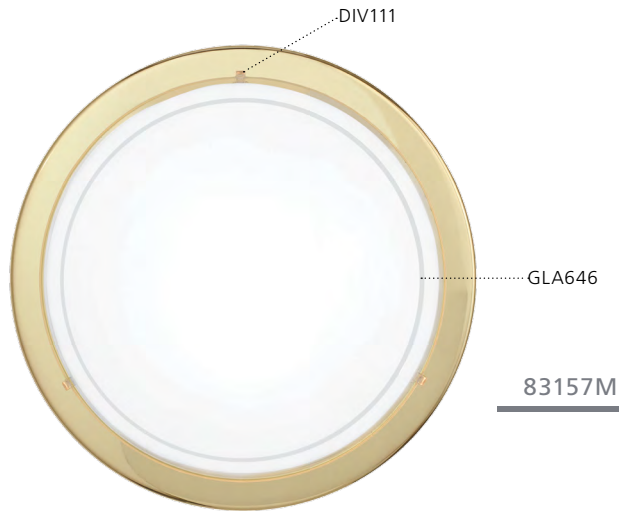

### 83155M PLANET 1

Luminario techo, pared; acero, cromo; cristal lacado, blanco, claro  
*wall, ceiling light; steel, chrome, coated glass, white, clear*  
 Ø 290, A 85

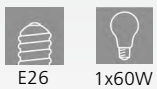

### 83157M PLANET 1

Luminario techo, pared; acero, bronce; cristal lacado, blanco, claro  
*wall, ceiling light; steel, bronze, coated glass, white, clear*  
 Ø 290, A 85

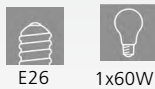

### 83162M PLANET 1

Luminario techo, pared; acero, níquel satinado; cristal lacado, blanco, claro  
*wall, ceiling light; steel, nickel satinated, coated glass, white, clear*  
 Ø 290, A 85

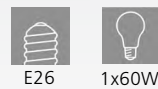

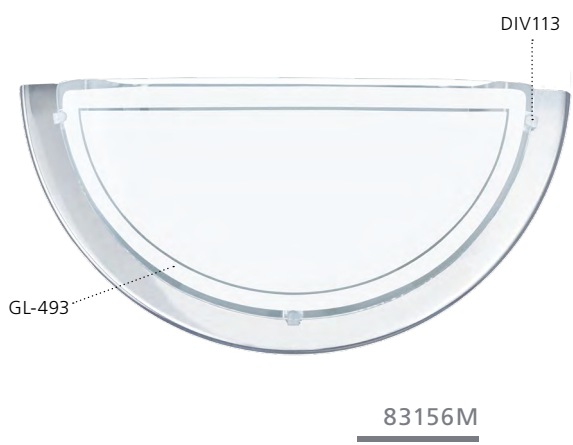

### 83156M PLANET 1

Luminario de pared; acero, cromo; cristal lacado, blanco, claro  
*wall light; steel, chrome, coated glass, white, clear*  
 L 290, H 145, A 85

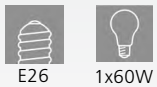

### 83158M PLANET 1

Luminario de pared; acero, bronce; cristal lacado, blanco, claro  
*wall light; steel, bronze, coated glass, white, clear*  
 L 290, H 145, A 85

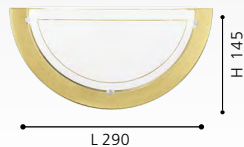

### 83163M PLANET 1

Luminario de pared; acero, níquel satinado; cristal lacado, blanco, claro  
*wall light; steel, nickel satined, coated glass, white, clear*  
 L 290, H 145, A 85





### 82941M PLANET

Luminario techo, pared; acero, níquel satinado; cristal satinado, blanco  
*wall, ceiling light; steel, nickel satinated, satinated glass, white*  
 Ø 370



### 82944M PLANET

Luminario techo, pared; acero, cromo; cristal satinado, blanco  
*wall, ceiling light; steel, chrome, satinated glass, white*  
 Ø 370



### 82945M PLANET

Luminario techo, pared; acero, cromo; cristal satinado, blanco  
*wall, ceiling light; steel, chrome, satinated glass, white*  
 Ø 290, A 85



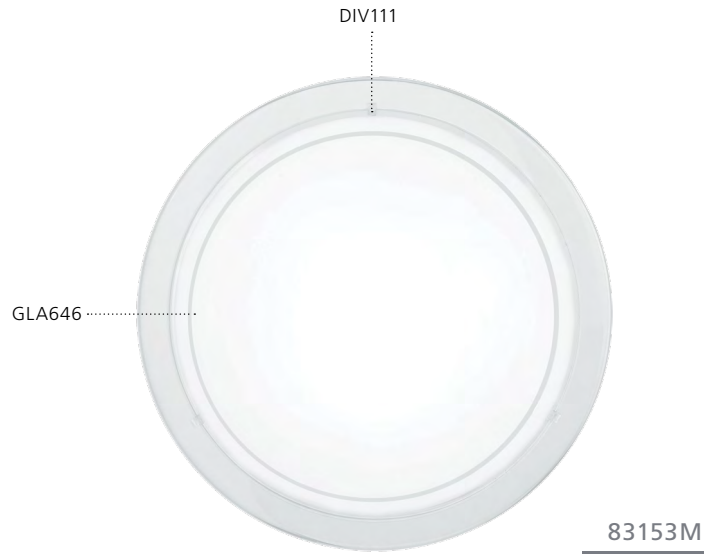

### 83154M PLANET 1

Luminario de pared; acero, blanco; cristal lacado, blanco  
*wall light; steel, white, coated glass, white*

L 290, H 145, A 85



E26



1x60W



### 82946M PLANET

Luminario de pared; acero, cromo; cristal satinado, blanco  
*wall light; steel, chrome, satinated glass, white*

L 290, H 145, A 85



E26



1x60W



### 83153M PLANET 1

Luminario techo, pared; acero, blanco; cristal lacado, blanco  
*wall light; steel, white, coated glass, white*

Ø 290, A 85



E26



1x60W



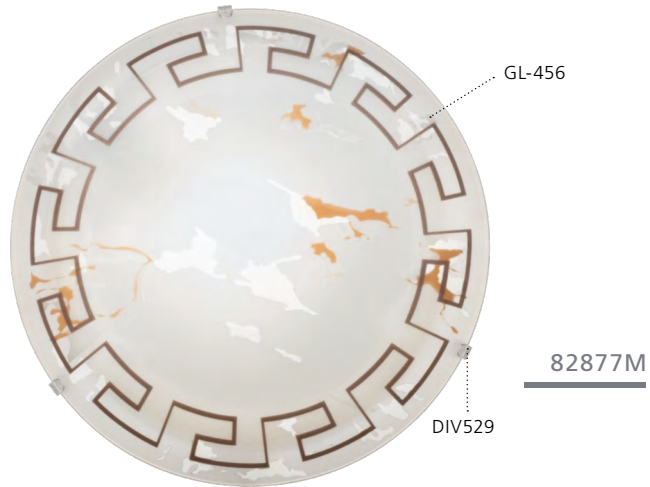

### 86873M TWISTER

Luminario techo, pared; acero, blanco; cristal satinado, diseño antiguo  
*wall, ceiling light; steel, white, satinated glass, design antique*  
 Ø 395

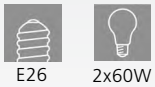

### 82877M TWISTER

Luminario techo, pared; acero, blanco; cristal satinado, diseño antiguo  
*wall, ceiling light; steel, white, satinated glass, design antique*  
 Ø 315



### 82891M TWISTER

Luminario techo, pared; acero, blanco; cristal satinado, diseño antiguo  
*wall, ceiling light; steel, white, satinated glass, design antique*  
 Ø 250

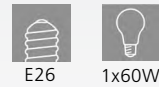



GL-457

82878M



82878M

## 82878M TWISTER

Luminario techo, pared; acero, blanco; cristal satinado, diseño antiguo  
*wall, ceiling light; steel, white, satinated glass, design antique*

L 300, A 150



E26



1x60W



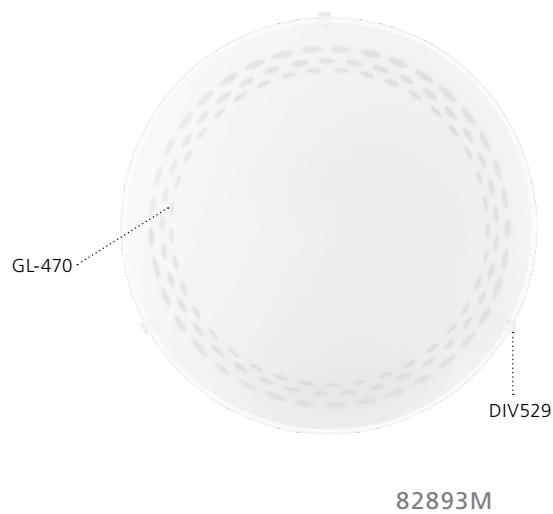
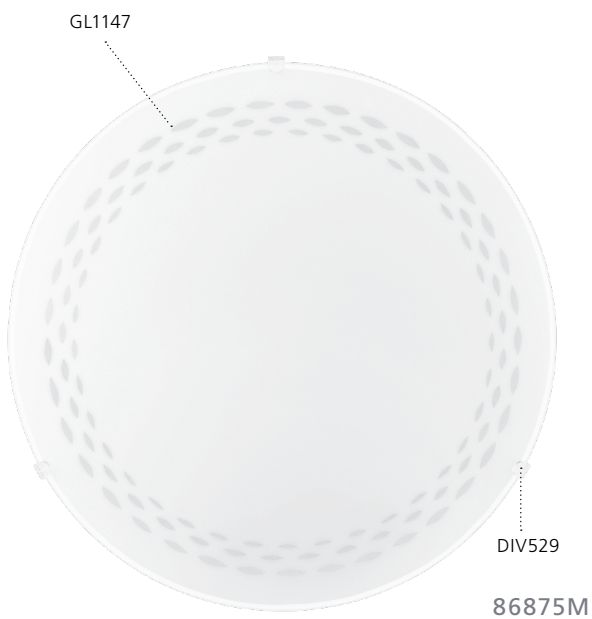
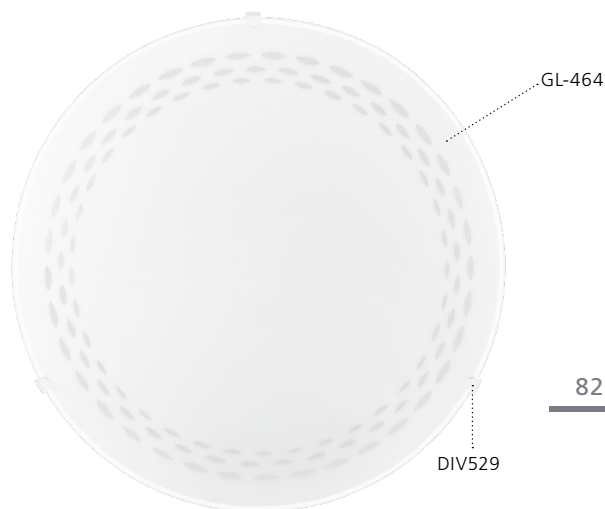

### 86875M TWISTER

Luminario techo, pared; acero, blanco; cristal satinado, diseño líneas  
*wall, ceiling light; steel, white, satinated glass, design stripes*  
 Ø 395



### 82886M TWISTER

Luminario techo, pared; acero, blanco; cristal satinado, diseño líneas  
*wall, ceiling light; steel, white, satinated glass, design stripes*  
 Ø 315

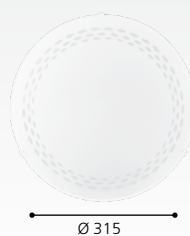

### 82893M TWISTER

Luminario techo, pared; acero, blanco; cristal satinado, diseño líneas  
*wall, ceiling light; steel, white, satinated glass, design stripes*  
 Ø 250





**82887M**



**80265M**



**91236M**

## 82887M TWISTER

Luminario de pared; acero, blanco; cristal satinado, diseño líneas  
*wall light; steel, white, satinated glass, design stripes*

L 300, A 150

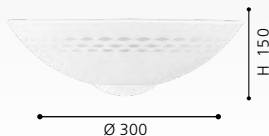

## 80265M MARS

Luminario techo, pared; acero, níquel satinado; cristal satinado, blanco  
*wall, ceiling light; steel, nickel satined, satinated glass, white*

Ø 245, A 70

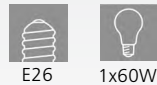

## 91236M MARS

Luminario techo, pared; acero, blanco; cristal satinado, blanco, decorado  
*wall, ceiling light; steel, white, satinated glass, decor*

Ø 250



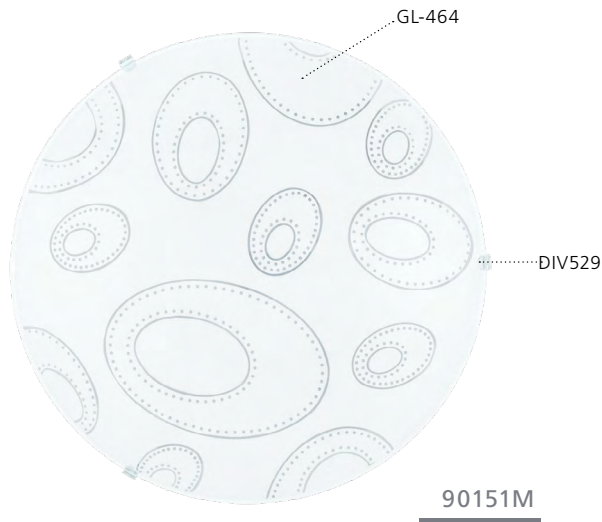
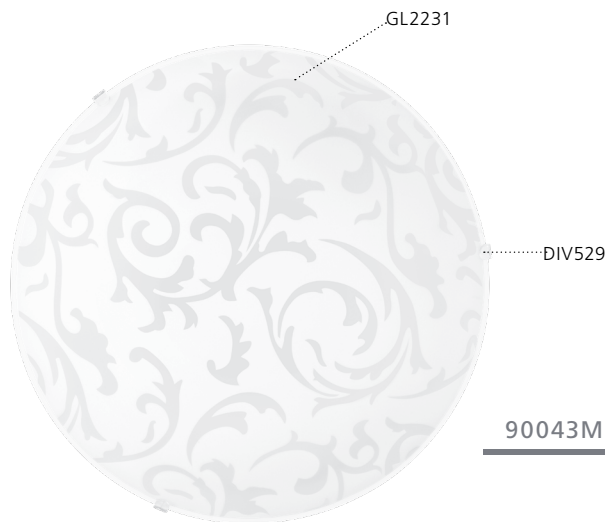

### 90151M SCALEA 1

Luminario techo, pared; acero, blanco; cristal con decoración, blanco, claro  
*wall, ceiling light; steel, white, glass with decoration, white, clear*  
 Ø 315, A 100



### 90043M SCALEA 1

Luminario techo, pared; acero, blanco; cristal satinado, blanco con decoración  
*wall, ceiling light; steel, white, satinated glass, white with decor*  
 Ø 315, A 100

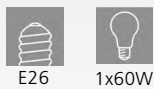

### 91808M MAGITA

Luminario techo, pared; acero, blanco; cristal con diseño impreso  
*wall, ceiling light; steel, white, glass printed with design*  
 Ø 315, A 95



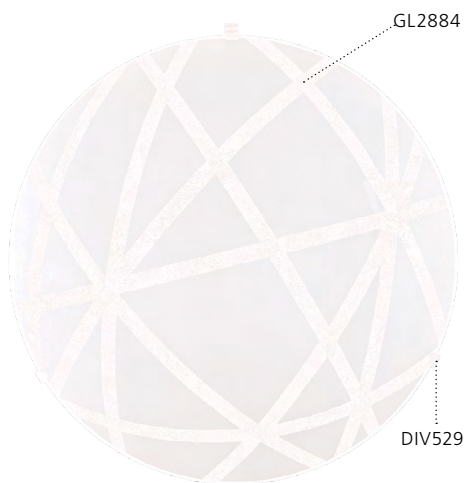

GL2884

DIV529

**92751M**



GL2181

MT1705

DIV529

**89758M**

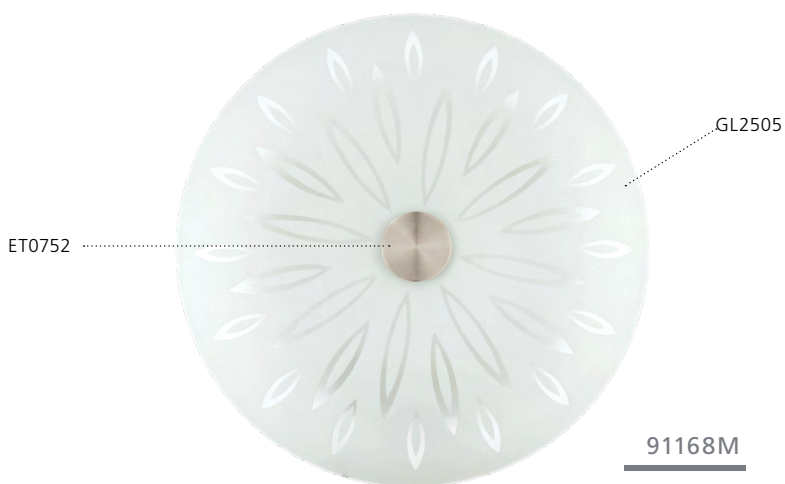

GL2505

ET0752

**91168M**

## 91168M CRATER

Luminario techo, pared; acero, blanco; cristal satinado, blanco  
*wall, ceiling light; steel, white, satinated glass, white*  
 Ø 470, A 75



E26



3x60W



Ø 470

## 92751M SABBIO

Luminario techo, pared; acero, blanco; cristal, blanco con diseño  
*wall, ceiling light; steel, white, glass, white with design*  
 Ø 315, A 95



E26



1x60W



Ø 315

## 89758M RAYA

Luminario techo, pared; acero, blanco, cromo; cristal satinado, blanco, plata  
*wall, ceiling light; steel, white, chrome; satinated glass, white, silver*  
 Ø 315, A 100



E26



1x60W



Ø 315



**20917M**

ET1254

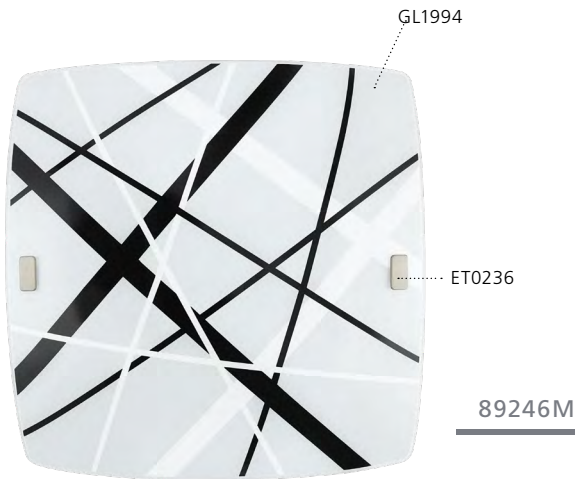

GL1994

ET0236

**89246M**



GL-597

ET0236

**83241M**

## 20917M GIRON

Luminario techo, pared; acero, blanco, plástico,  
blanco

*ceiling, wall light; steel, white, plastic,  
white*

Ø 480, A 120



T5  
1x40W

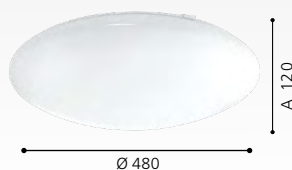

## 83241M BORGIO

Luminario de techo; satinado, cristal, blanco  
*ceiling light; satined, glass, white*

L 240, H 240



E26



1x60W

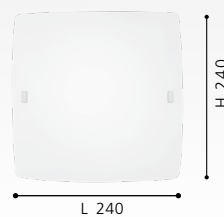

## 89246M MILLA 3

Luminario techo, pared; acero, blanco, cristal  
satinado, blanco, negro, diseño con líneas  
*wall, ceiling light; steel, white, satinated glass,  
white, black, design stripes*

L 340, H 340, A 95



E26



1x60W

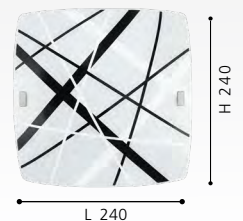



## 20494M SCALEA 1

Luminario pared,techo; cromo, cristal blanco decorado  
*wall, ceiling light; chrome, white glass decor*

L 410, H 410, A 95

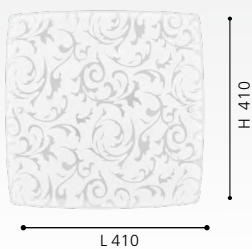

## 92914M SABBIO 1

Luminario pared, techo; acero, blanco, cristal, blanco  
*wall, ceiling light; steel, white, glass, white*

H 410, L 410, A 95

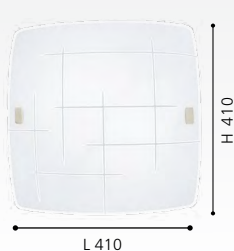
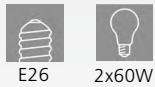

## 93007M SABBIO 1

Luminario pared, techo; acero, blanco, cristal, blanco  
*wall, ceiling light; steel, white, glass, white*

L 335, H 335, A 95

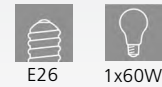



### 84026M GRAFIK

Luminario pared, techo; acero, cristal satinado, blanco  
*wall, ceiling light; steel, satinated glass, white*

L 280, H 290, A 90



E26



1x60W

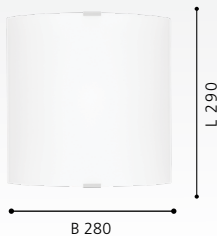

### 84028M GRAFIK

Luminario pared, techo; acero, cristal satinado, blanco  
*wall, ceiling light; steel, satinated glass, white*

L 180, H 210, A 95



E26



1x60W



### 85979M TROY 3

Luminario pared; acero, níquel satinado, cristal satinado, blanco  
*wall light; steel, nickel satinated, satinated glass, white*

L 180, H 250, A 75



E26



1x60W



GL2278 .....



**90049M**



GL-425 .....

**20661M**



**90049M**

## 90049M AMADORA

Luminario pared; acero, blanco, cristal satinado, blanco, decoración blanca  
*wall light; steel, white, satinated glass, white, white decor*

L 180, H 250, A 75



E26



1x60W



H 250

A 75

## 20661M VIVA

Luminario pared; acero, níquel satinado; cristal satinado blanco  
*wall light; steel, satinated nickel; glass satinated, white*

L 175, H 200



E26



1x60W



H 200

L 175

# ETIQUETAS DE EFICIENCIA ENERGÉTICA

## ENERGY EFFICIENCY LABELS

### LUMINARIAS LED

Las luminarias LED son cada vez más populares y la demanda de soluciones energéticamente eficientes está ganando fuerza. Esto ha dado lugar a la adopción de varias regulaciones de la UE que prescriben el etiquetado de eficiencia energética de las fuentes de luz y luminarias. Hemos preparado una breve descripción de las nuevas etiquetas energéticas.

### LED LUMINAIRES

LED luminaires are increasingly popular and the demand for energy efficient solutions is gaining strength. This has resulted in the adoption of several EU regulations prescribing the energy efficiency labelling of light sources and luminaires. We have prepared a brief overview of the new energy labels.



# ETIQUETAS DE EFICIENCIA ENERGÉTICA

## ENERGY EFFICIENCY LABELS

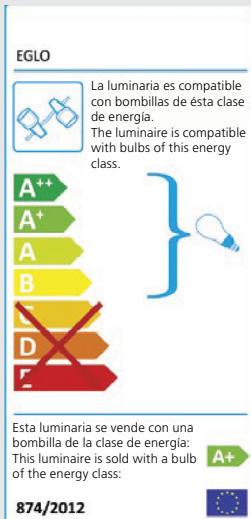

La información dentro del paréntesis en el centro de la etiqueta indica qué bombillas pueden usarse para la luminaria. En este caso, el producto solo es compatible con bombillas con una calificación de eficiencia energética mayor que C.

The information in brackets at the centre of the label indicates which bulbs may be used for the luminaire. In this case, the product is only compatible with bulbs with an energy efficiency rating of better than C.

Si se incluyen bombillas con la luminaria, sus clases de energía se indican en la parte inferior de la etiqueta.

If bulbs are included with the luminaire, their energy classes are indicated at the bottom of the label.

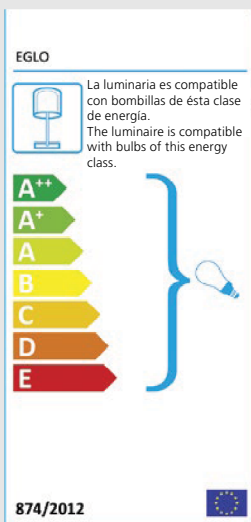

Esta etiqueta indica que no se incluyen bombillas con la luminaria. Los consumidores son libres de elegir su bombilla preferida dentro de las clases de energía indicadas.

This label indicates that no bulbs are included with the luminaire. Consumers are free to choose their preferred bulb within the indicated energy classes.

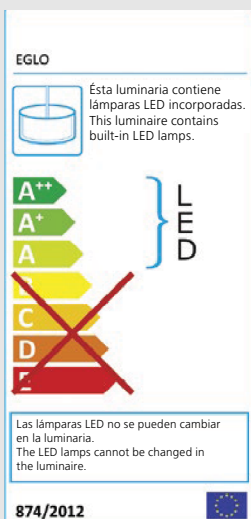

Esta etiqueta indica que la luminaria se vende con Lámparas LED incorporadas que no pueden ser reemplazadas por el consumidor.

This label indicates that the luminaire is sold with built-in LED lamps that cannot be replaced by the consumer himself.

### EEI BUTTONS

bulbs included  
focos incluidos



incl. placas LED altamente eficientes (no puede ser reemplazado por el consumidor final)  
incl. highly efficient LED boards (cannot be replaced by the end consumer)



incl. focos LED altamente eficientes  
incl. highly efficient LED bulbs



incl. LED eficientes y / o focos fluorescentes  
incl. efficient LED and/or fluorescent bulbs



incl. focos halógenos  
incl. halogen bulbs

## PICTOGRAMAS

### FURTHER PICTOGRAMMES

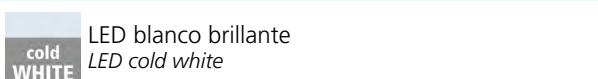
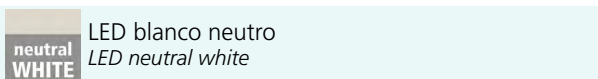
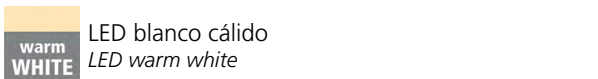
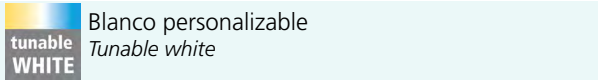
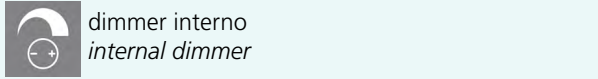
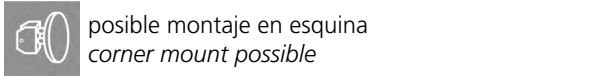
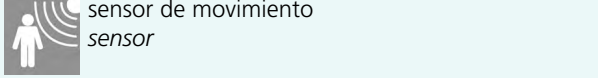
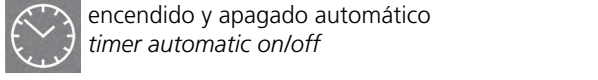
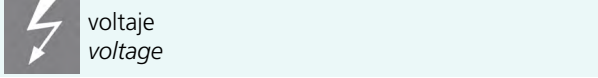
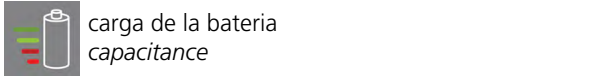
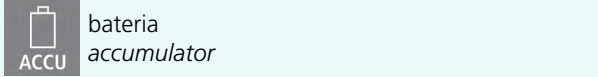
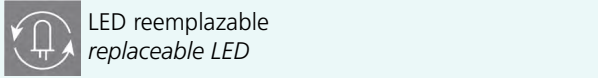
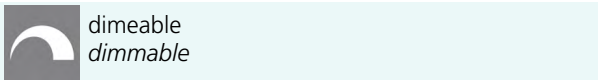

Etiquetas EEI no incluidas/EEI bulbs not included



Etiquetas EEI incluidas/EEI bulbs included



## SOCKETS

### SOCKETS

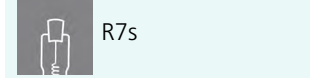
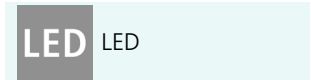
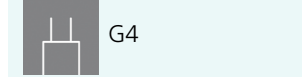
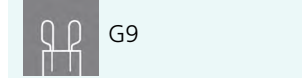
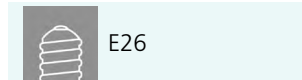

## FOCOS

### BULBS

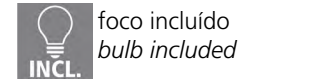
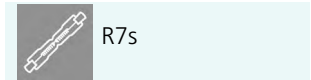
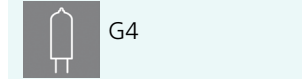
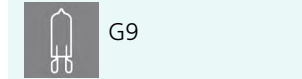
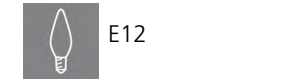
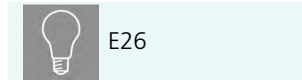

## APAGADORES

### SWITCHES

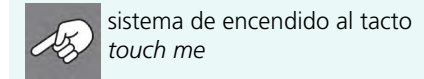
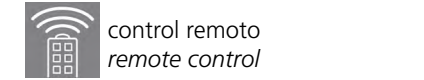
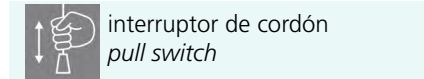
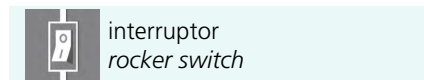

## CLASE DE PROTECCIÓN PROTECTION CLASS

La clase de protección indica hasta qué punto la lámpara está protegida contra las descargas eléctricas. Todas las lámparas de este catálogo cuentan con la clase de protección 1-, en caso de tener una protección más alta ésta se especifica en el cuadro de información del luminario correspondiente.

*The protection class indicates to what extent the lamp is protected against electric shock. All lamps in this catalogue are at least protected with the protection class 1 - a higher class is specified in the information box of the respective lamp.*



protección clase 1: tierra  
protection class 1: protective earthing



protección clase 2: aislante  
protection class 2: protective insulation



protección clase 3: bajo voltaje  
protection class 3: protective low voltage

## GRADO DE PROTECCIÓN PROTECTION RATING

El grado de protección garantiza la seguridad del funcionamiento de las luminarias. El primer número indica el alcance de la protección contra la penetración de cuerpos extraños, y el segundo número identifica el grado de protección contra la humedad. Todas las luminarias de este catálogo están protegidos por lo menos con la calificación IP20 - una calificación más alta se especifica en el cuadro de información de la luminaria.

*The protection rating ensures the operational safety of luminaires. The first number specifies the extent of the protection against the ingress of foreign bodies; the second number identifies the humidity protection grade. All luminaires in this catalogue are at least protected with the rating IP20 - a higher rating is specified in the information box of the luminaire.*



IP 33



IP 44



IP 54



IP 65



Colour Rendering Index

L = longitud | length

B = anchura | width

H = altura | height

Ø = diametro | diameter

A = longitud de proyección | projection length

ET = profundidad de instalación | installation depth

Base = dimensiones base | base dimensions

## CLASE DE PROTECCIÓN PROTECTION CLASS

La descripción del producto está compuesta de la siguiente manera: tipo de luminaria; acabado del material, color, cristal o material de la pantalla, cristal o color de la pantalla.

*The product description is composed as follows: luminaire type; enclosure material, enclosure colour, glass or shade material, glass or shade colour*



NUMERO DE ARTICULO/  
NOMBRE DE LA FAMILIA

### 204922A BOYAL

Luminario colgante LED; acero, negro-café rústico, plástico blanco  
pendant light; steel, wood, black, brown rustic; plastic, white

L 1010, B 400, H 1975

LED warm WHITE  
2x12W 2x 1700lm

LED warm WHITE  
1X16W 2250lm



PICTOGRAMAS

DESCRIPCIÓN

DIMENSIONES

BOCETO

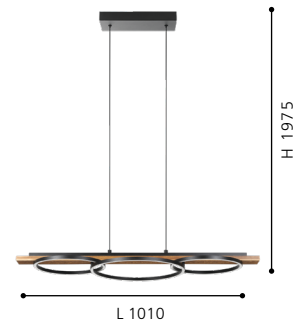

# EGLO EN EL MUNDO

## EGLO WORLDWIDE



 **HEADQUARTERS**  
EGLO LEUCHTEN GMBH  
Heiligkreuz 22  
A-6136 PILL  
T: +43 5242 6996 0 | F: +43 5242 6996 972  
E: info-austria@eglo.com

 **AUSTRALIA**  
EGLO LIGHTING AUSTRALIA  
5/339 Archerfield Road  
Richlands | Queensland 4077  
T: +61 7 3375 1413 | F: +61 7 3375 1412  
E: info-australia@eglo.com

 **BELGIUM**  
EGLO BELGIUM B.V.B.A.  
Antwerpsesteenweg 247 | B-2950 Kapellen  
Visit Adress: Innovatiepark 20 |  
4906 AA OOSTERHOUT (NL)  
T: +32 3 250 60 80 | F: +32 3 219 80 67  
E: info-belgium@eglo.com

 **BOSNIA-HERZEGOVINA**  
EGLO RASVJETA BH D.O.O.  
Ormanica bb  
BIH-76250 GRADACAC  
T: +387 35 86 85 00 | F: +387 35 82 44 41  
E: Info-Bosnia-Herzegovina@eglo.com

 **BULGARIA**  
EGLO BULGARIA EOOD  
Main Road Burgas-Sofia, 5th kilometer,  
Building KACHIKA, 8000 BOURGAS, Bulgaria  
T: +359 56 960 403 | F: +359 56 53 05 95  
E: info-bulgaria@eglo.com

 **CANADA**  
EGLO CANADA INC.  
20700 Route Transcanadienne  
Baie-D'Urfé, Québec | H9X 4B7  
T: +1 514 457 5483 | F: +1 514 457 5487  
E: info-canada@eglo.com

 **CHILE - SANTIAGO**  
EGLO CHILE ILUMINACION LTDA.  
Av. América Vespucio 1930  
Conchalí - SANTIAGO DE CHILE  
T: +562 2 595 2222  
E: info-chile@eglo.com

 **CHINA**  
DONGGUAN EGLO CHINA LIGHTING CO., LTD.  
No.1 | Shangqiao Industrial Road | Shangqiao,  
Dongcheng District  
DONGGUAN CITY, GUANZHOU PROVINCE | CHINA  
T: +86 769 2203 3866 | F: +86 769 2203 6866  
E: info-china@eglo.com

 **COLOMBIA**  
EGLO COLOMBIA ILUMINACION SAS  
AUTOPISTA NORTE KM 19 COSTADO LOTE 30  
BOGOTÁ - CHIA  
T: +57 (1) 744 2339  
E: info-global@eglo.com

 **COSTA RICA**  
EGLO Costa Rica, Centro Comercial Calle Real local #8  
Guachipilín de Escazú de la sucursal del BAC  
San Jose 800 metros al norte San Jose Costa Rica.  
T: +506-2289-4690, +506-2100-6384  
E: Info-CostaRica@eglo.com

 **CROATIA**  
EGLO RASVJETA D.O.O.  
Josipa Lončara 3  
HR-10000 ZAGREB  
T: +385 1 379 40 62 | F: +385 1 379 41 04  
E: info-croatia@eglo.com

 **CZECH REPUBLIC**  
EGLO CZ+SK s.r.o.  
Náhodská 2479/63  
CZ-193 00 PRAHA 9 Horní Počernice  
T: +420 281 924 163 | F: +420 281 925 205  
E: info-czechrepublic@eglo.com

 **DENMARK**  
EGLO DANMARK A/S  
Agerbakken 20  
DK-8362 Hørring  
T: +45 70 22 55 11 | F: +45 70 22 55 21  
E: info-denmark@eglo.com

 **ESTONIA**  
MOODNE VALGUSTUS AS  
Rävala pst. 7  
EE-10143 TALLINN  
T: +372 667 6670 | F: +372 631 3195  
E: info-global@eglo.com

 **FINLAND**  
EGLO FINLAND OY  
Malminraitti 17A  
00700 Helsinki  
T: +358 20 7649 820 | F: +358 20 7649 821  
E: info-finland@eglo.com

 **FRANCE**  
EGLO FRANCE LUMINAIRE SARL  
Z.A. Jeune Bois | 2 Rue de la Martinique  
F-68274 WITTENHEIM  
T: +33 389 6250 30 | F: +33 389 6250 49  
E: info-france@eglo.com

 **GERMANY**  
EGLO LEUCHTEN HANDELS GMBH  
Kleinbahnstr. 35  
D-59759 ARNSBERG  
T: +49 2932 6269 0 | F: +49 2932 6269 39  
E: info-germany@eglo.com

 **GREECE**  
EGLO HELLAS A.E.  
Sykias 2 and parodos dekeleias  
ACHARNAI, GR-13679  
T: +30 210 240 77 10 | F: +30 210 240 07 29  
E: info-greece@eglo.com



**GREAT BRITAIN**  
EGLO UK LTD.  
Unit 12 Cirrus Park, Lower Farm Road, Moulton Park  
Industrial Estate, NORTHAMPTON NN3 6UR  
T: +44 1604 790 986 | F: +44 1604 670 282  
E: info-greatbritain@eglo.com



**MOROCCO**  
EGLO AFRICA  
219 Bd Med Zerktouni. Suite: 67  
20330 CASABLANCA | Morocco  
T: +212 522 98 80 25 / 05  
E: info-global@eglo.com / info.africa@eglo.com



**SPAIN**  
EGLO ESPANA ILUMINACION S.L.  
Avda. de Castilla 1 (Edf. Best Point) 2º-16A  
San Fernando de Henares, E-28830 MADRID  
T: +34 91 677 9044 | F: +34 91 677 0304  
E: info-spain@eglo.com



**HUNGARY - PRODUCTION & LOGISTICS**  
EGLO MAGYARORSZAG KFT.  
Fő út. 155  
H-3060 PASZTO  
T: + 36 32 560 050 | F: +36 32 560 040  
E: info-hungary@eglo.com



**THE NETHERLANDS**  
EGLO VERLICHTING NEDERLAND B.V.  
Innovatiepark 20  
4906 AA OOSTERHOUT (NBR)  
T: +31 162 48 28 30 | F: +31 162 48 28 40  
E: Info-Netherlands@eglo.com



**SWEDEN**  
EGLO SVERIGE AB  
Star Street 1  
SE-512 50 SVENLJUNGA  
T: +46 340 623 505 | F: +46 340 623 605  
E: info-sweden@eglo.com



**INDIA**  
EGLO INDIA PRIVATE LIMITED  
A-307 Ansal Chamber-1, 3 Bhikaji Cama Place,  
New Delhi-110066  
T: +91 981 108 2205 | T: +91 999 961 0450  
E: info-india@eglo.com



**NORWAY**  
MS Belysning AS  
Heiaveien 4  
NO-1900 FETSUND  
T: +47 63 888500 | F: +47 63 888501  
E: info-norway@eglo.com



**SWITZERLAND**  
EGLO SCHWEIZ AG  
Seetalstraße 142  
CH-6032 EMMEN  
T: +41 41 268 69 59 | F: +41 41 268 69 58  
E: info-switzerland@eglo.com



**ITALY**  
EGLO ITALIANA S.R.L.  
Via Giotto, 4  
I-31021 MOGLIANO VENETO (TV)  
T: +39 041 45 66 232/245/251 | F: +39 041 45 74 066/071  
E: info-italy@eglo.com



**PERU**  
EGLO PERU S.A.C  
Avda. Santa Cruz No. 458 Distrito de San Isidro  
Provincia y Departamento Lima, San Isidro - Lima  
T: +51 1 4212 158  
E: info-peru@eglo.com



**TURKEY**  
Eglo Aydınlatma İthalat İhracat Ltd. Şti.  
Eyüp Sultan Mah. Sekmen Cad. No:18/2  
34855 SAMANDIRA, SANCaktepe / İSTANBUL  
T: +90 216 311 09 -02 / -03 / -04 | F: +90 216 311 09 -05  
E: info-turkey@eglo.com



**KAZAKHSTAN**  
EGLO KAZAKHSTAN LLP  
Office 72, 14<sup>th</sup> floor, Block 4A, Nurlı-Tau Business Centr,  
Al-Farabi Avenue 7, 050059 Almaty, Kazakhstan  
T: +7 727 293 25 20 | M: +7 701 031 00 00  
E: info-kazakhstan@eglo.com



**POLAND**  
EGLO POLSKA SP. Z.O.O.  
Ul. Pulawska 479  
02-844 WARSZAWA  
T: +48 22 644 57 55 | F: +48 22 644 89 82  
E: info-poland@eglo.com



**USA**  
EGLO USA, INC.  
3640 Royal South Parkway  
ATLANTA, GEORGIA 30349  
T: +1 404 477 5601 | F: +1 404 393 7053  
E: info-usa@eglo.com



**KOSOVO**  
EGLO KOSOVA LLC  
Lugisht e qytetit pn  
20000 PRIZREN- KOSOVO  
T: +377 44 2166 87 | Shop: +381 29 2442 84  
E: info-kosovo@eglo.com



**PORTUGAL**  
EGLO PORTUGAL ILUMINAÇÃO, LDA  
Rua Fonte Parada, 125  
PT-4595-434 SEROA-PAÇOS DE FERREIRA  
T: +351 255 890 000 | F: +351 255 892 346  
E: info-portugal@eglo.com



**UKRAINE**  
EGLO UKRAINE LTD  
bulv. Vatslav Havel 6/7A  
UA-03680 KIEV  
T: +38 044 463 98 41 | F: +38 044 468 84 67  
E: info-ukraine@eglo.com



**LITHUANIA**  
MOODNE VALGUSTUS AS  
Rāvāla pst. 7  
EE-10143 TALLINN  
T: +370 652 49923 | T: +372 667 6670  
E: info-lithuania@eglo.com



**ROMANIA**  
EGLO ROMANIA PRODEXIM SRL.  
Str. Atomistilor nr. 1D  
R-077125 MAGURELE - ILFOV - ROMANIA  
T: +40 314 250 902 | F: +40 314 250 899  
E: info-romania@eglo.com



**MAGYARORSZÁG – ÉRTÉKESÍTÉS**  
EGLO LUX KFT.  
Fő út. 143/A  
H-2120 DUNAKESZI  
T: +36 27 341 353 | F: +36 27 341 409  
E: info-hungary@eglo.com



**RUSSIA**  
EGLO LIGHTING LLC  
Varshavskoe shosse 35 | Building 1  
RU-117105 | MOSCOW  
T: +7495 789 4311 | F: +7495 789 4312  
E: info-russia@eglo.com



**MALAYSIA**  
EGLO ASIA SDN BHD  
No. 13, Jalan Pelukis U1/46B, Temasya 18, Glenmarie,  
40150 Shah Alam, Selangor Darul Ehsan, Malaysia  
T: +6011 1050 2336 | F: +603 5567 9415  
E: info-malaysia@eglo.com



**SERBIA**  
EGLO RASVETA DOO  
Stefana Prvoventanog 28  
11000 BEOGRAD | SRBIJA  
T: +381 11 3981 366 | F: +381 11 3981 389  
E: info-serbia@eglo.com



**MEXICO**  
EGLO MÉXICO ILUMINACIÓN S DE RL DE CV  
Prolongación Avenida López Mateos Sur N°3561,  
Fraccionamiento Los Gavilanes.  
C.P. 45645, Tlajomulco de Zúñiga, Jalisco, México  
T: +52 33 3687 20 95 | E: info-mexico@eglo.com



**SLOVAKIA**  
EGLO CZ+SK s.r.o  
Náhodská 2479/63  
CZ-193 00 PRAHA 9 Horní Počernice  
T: +421 313 211 551 | F: +421 313 211 556  
E: info-slovakia@eglo.com



**MIDDLE EAST**  
EGLO LIGHTING MIDDLE EAST FZE  
P.O. BOX 262073, LOB 6, OFFICE G18  
JEBEL ALI, DUBAI, UAE  
T: +97 148810080 | F: +97 148810081  
E: info.me@eglo.com



**SLOVENIA**  
EGLO RASVJETA D.O.O.  
Josipa Lončara 3  
HR-10000 ZAGREB  
T: +386 158 093 18  
E: info-slovenia@eglo.com

# REGISTRO

NOMBRE DE SERIES

SERIES NAMES

ABNER	249	BOLANOS	102	CARDITO	119	DEBED	142
ABNER	249	BOND	259	CARDITO 1	118	DEBED	142
ADRI 3	186	BORDESLEY	169	CARLTON	156	DEMBLEBY	169
ADRI 3	207	BORDESLEY	169	CARLTON	156	DIAMOND	145
AGUILARES	131	BORGO	284	CARLTON 1	157	DODO	259
ALAMONTE 1	253	BOSARO	242	CARLTON 1	156	DONINNI	245
ALAMONTE 1	253	BOYAL	112	CARLTON 1	158	DONINNI	245
ALAMONTE 1	253	BOYAL	112	CARLTON 1	157	DOREEN	233
ALAMONTE 3	252	BOYAL	112	CARLTON 1	157	DUGLIA	39
ALAMONTE 3	252	BRANDEL	250	CARPI 1	179	DUGLIA	40
ALBARINO	46	BRANDEL	250	CARPI 1	179	EDALE	170
ALBARINO	46	BREA	195	CARRARO	248	EDALE	170
ALMERA	206	BREA	195	CAVO	206	ELIZONDO	187
ALMONTE	228	BREA	194	CERASELLA	131	EMBLETON	152
ALOBRASE	130	BREA	194	CHESTER-P	208	ERMUA	136
ALTAMIRA	62	BROMWICH	152	CHESTER-P	207	ESCUELA	82
AMADORA	287	BUDRONE	248	CHESTER-P	207	ESTEPERRA	81
ANTELAO	31	BULCIAGO	43	CHESTER-P	208	FABIANA 1	120
ANTELAO	32	BULCIAGO	43	CHIETINO	205	FABIANA 1	120
ANTELAO	33	BULCIAGO	44	CLEVEDON	167	FABIANA 1	120
ARENALES	58	BULCIAGO	45	CLIMENE	137	FALCADO	146
ARENALES	59	CABEZOLA	34	COMBWICH	153	FANDINA	239
ARKTIC	258	CABEZOLA	35	COMBWICH 1	153	FANDINA	239
ASCOLI 1	257	CALAONDA	22	COMPETA 1	230	FEDRA	145
ASCOLI 1	257	CALAONDA	21	COMPETA 1	178	FORNES	139
AUCKLAND	159	CALAONDA	21	CONTRISA	141	FOSSOMBRONE	264
BARI	233	CALAONDA	20	CONTRISA	141	FRISCOLI	229
BARI-M	231	CALAONDA	23	COPLEY	214	GILWELL	110
BARNSTAPLE	151	CALDIERO	247	CORDOBA	41	GILWELL	110
BASILDON	164	CALDIERO	247	CORDOBA	42	GIRON	284
BASILDON	164	CALMEILLES	25	CORETTO 2	155	GLENN	197
BASILDON	164	CALMEILLES	25	CORETTO 2	155	GLENN	197
BAYMAN	123	CALMEILLES	24	CORETTO 4	142	GRADOLI	135
BAYMAN	122	CALMEILLES	24	CORTADERAS	107	GRADOLI	135
BAYMAN	122	CAMACHO	202	CORTADERAS	107	GRADOLI	135
BAYMAN	122	CAMACHO	202	CORTADERAS	107	GRAFIK	286
BAYMAN	123	CAMACHO	217	CORTENOVA	104	GRAFIK	286
BAYMAN	123	CAMARGO	140	CORTENOVA	105	GRANADILLOS	79
BERNABETA	36	CAMPODINO	205	CORTENOVA	104	GRANADILLOS	80
BERNABETA	37	CAMPORALE	204	CORTENOVA	104	GRANADILLOS	80
BIDFORD	203	CAMPORALE	204	COTTINGHAM	166	GRIMALDINO	180
BIDFORD	203	CANOPY	108	COTTINGHAM	166	HALVA	116
BOLANOS	100	CANOPY	108	CRATER	283	HALVA	116
BOLANOS	101	CANOPY	108	CULPINA	243	HALVA	116
BOLANOS	100	CARDITO	118	CULPINA	243	HALVA	117
BOLANOS	101	CARDITO	118	DAMBERA	182	HALVA	117

# REGISTRO

NOMBRE DE SERIES

SERIES NAMES

HALVA	117	MASETA	134	PALMERA 1	224	PREDAZZO	241
HAPTON	155	MATLOCK	159	PALMERA 1	224	PRIDDY	152
HILBURN 1	260	MAURICIO	196	PALMERA 1	223	RAMON	143
HORNWOOD 2	160	MAURICIO	196	PALMERA 1	223	RAMPSTEAD	168
ISIDRO	217	MEDUNO	146	PALMERA 1	222	RASIGURES	68
JABALOYAS	187	MELDOLA	178	PALMERA 1	222	RASIGURES	69
JAZMINIA	55	MELGOA	250	PALMITAL	217	RAYA	283
JUMILLA	192	MENTALONA	73	PALOZZA	103	RIBAS	176
JUMILLA	192	MENTALONA	74	PALOZZA	103	RIGA 1	256
KIBEA	240	MENTALONA	75	PALOZZA	103	RIGA 1	255
KIBEA	240	MIERE	225	PALTAS	138	RIGA 1	256
LACEY	201	MIERE	225	PARDELA	243	RIGA 1	255
LACEY	201	MIERE	225	PAUSIA	188	RIGA 1	255
LADUNARA	264	MILLA 3	284	PAZ	60	RIGA 5	254
LAGUNITAS	132	MILLIGAN	149	PAZ	60	RIGA 5	254
LAGUNITAS	132	MILLIGAN	149	PAZ	61	ROCAMAR	144
LASANA	176	MILLIGAN	149	PEDREGAL	205	ROMENDO	226
LASANA	176	MILLIGAN	150	PIANOPOLI	18	ROMENDO	226
LED CARPI	230	MILLIGAN	150	PIANOPOLI	19	ROMENDO	227
LERIDA	178	MILLIGAN	150	PIANOPOLI	17	ROMENDO	226
LIBERTAD	216	MIRAFLORES	138	PIANOPOLI 1	16	RONDO	125
LINDOZA	72	MONO	232	PIERINO	193	RONDO	125
LINDOZA	71	MONO	232	PIERINO	193	SABALETE	140
LORET TO	229	MONO	232	PINTO	206	SABBIO	283
LUBENHAM	153	MONTEFIO 2	15	PINTO	121	SABBIO 1	285
MADRONA	244	MONTENOVO	268	PINTO NERO	121	SABBIO 1	285
MADRONA	244	MONTEY	98	PINTO NERO	121	SALOME	270
MADRONA	218	MONTEY	98	PLANET	276	SALOME	272
MADRONA	220	MOUNA	260	PLANET	276	SALOME	272
MADRONA	218	NASTASIA	114	PLANET	276	SALOME	270
MADRONA	220	NASTASIA	114	PLANET 1	277	SALOME	272
MAGITA	282	NEVADO	139	PLANET 1	277	SALOME	271
MALVA	273	NEWTOWN	167	PLANET 1	277	SALOME	271
MALVA	273	NOCELLA	246	PLANET 1	274	SALOME	271
MALVA	273	NOCELLA	246	PLANET 1	275	SALVEZINAS	53
MARAGALL	50	NOMO	188	PLANET 1	274	SANIA 3	185
MARAGALL	52	NOVENTA	99	PLANET 1	275	SANIA 3	184
MARAGALL	51	NOVENTA	99	PLANET 1	274	SANIA 3	184
MARINELLA	10	OILELLA	94	PLANET 1	275	SANIA 3	185
MAROJALES	181	OILELLA	94	POLICARA	209	SANTANDER	209
MARS	281	OILELLA	94	POLVERARA	48	SAPUARA	29
MARS	281	OILELLA	95	POLVERARA	48	SAPUARA	30
MARYSVILLE	168	ORMOND	182	POLVERARA	49	SAVARNA	89
MARYVILLA	133	PADSTOW	165	PORTSEA	11	SCALEA 1	285
MARYVILLA	133	PADSTOW	165	PRATA VECCHIA	251	SCALEA 1	282
MASETA	134	PALERMO	224	PREDAZZO	241	SCALEA 1	282

# REGISTRO

NOMBRE DE SERIES

SERIES NAMES

SELVINO	96	TOWNSHEND 5	163
SELVINO	96	TOWNSHEND 5	161
SELVINO	97	TOWNSHEND 5	162
SELVINO	97	TOWNSHEND 5	162
SENDERO	137	TOWNSHEND-B	87
SERRICELLA	239	TROY 3	124
SINSIGA	56	TROY 3	124
SINSIGA	57	TROY 3	286
SIRACUSA	47	TROY 3	124
SIRACUSA	144	TWISTER	278
SIRMIONE	251	TWISTER	279
SKOURA	66	TWISTER	280
SKOURA	63	TWISTER	281
SKOURA	63	TWISTER	278
SKOURA	64	TWISTER	280
SKOURA	64	TWISTER	278
SKOURA	65	TWISTER	280
SKOURA	67	UPANEMA	88
TABIANO	221	VALLASPRA	181
TABIANO	221	VALPARAISO	26
TABIANO	221	VALPARAISO	27
TABIANO	220	VARILLAS	143
TAMARESCO	84	VENTO	258
TAMARESCO	85	VIVA	287
TARBES	215	ZIMBA	258
TAZZOLI	183	ZIMBA LED	261
TAZZOLI	183	ZIMBA LED	261
TOLEDA	268	ZIMBA LED	262
TONARELLA	76	ZIMBA LED	262
TONARELLA	77		
TORONJA	145		
TORRENTES	130		
TORTOLA	83		
TORTORETO	174		
TORTORETO	174		
TORTORETO	174		
TORTORETO	175		
TORTORETTO	106		
TORTORETTO	106		
TORTORETTO	106		
TOWNSHEND 1	139		
TOWNSHEND 4	154		
TOWNSHEND 4	154		
TOWNSHEND 5	161		
TOWNSHEND 5	161		
TOWNSHEND 5	162		

# REGISTRO

## ARTICLE NUMBER

7183	SALOME	270	39537	POLVERARA	48	39977	SAPUARA	29	49052	AUCKLAND	159
7184	SALOME	272	39538	POLVERARA	48	39978	SAPUARA	30	49139	TOWNSHEND	1139
7186	SALOME	272	39539	POLVERARA	49	43131	TOWNSHEND 5	161	49141	CLEVEDON	167
7187	SALOME	270	39545	PIANOPOLI 1	16	43132	TOWNSHEND 5	161	49146	BROMWICH	152
7188	SALOME	272	39547	MONTEFIO 2	15	43133	TOWNSHEND 5	162	49148	BIDFORD	203
7901	SALOME	271	39592	SALVEZINAS	53	43134	TOWNSHEND 5	163	49156	BIDFORD	203
7902	SALOME	271	39613	CALMEILLES	25	43135	TOWNSHEND 5	161	49257	CARLTON	156
7903	SALOME	271	39614	CALMEILLES	25	43136	TOWNSHEND 5	162	49386	CHESTER-P	208
20223	ALMERA	206	39619	SKOURA	66	43137	TOWNSHEND 5	162	49449	HAPTON	155
20494	SCALEA 1	285	39626	CALMEILLES	24	43152	TOWNSHEND 4	154	49467	PRIDDY	152
20507	NOMO	188	39627	CALMEILLES	24	43162	LUBENHAM	153	49479	NEWTOWN	167
20508	PINTO	121	39634	RASIGURES	68	43215	COMBWICH	153	49718	BARNSTAPLE	151
20597	PINTO	206	39635	RASIGURES	69	43216	BORDESLEY	169	49859	TOWNSHEND 4	154
20661	VIVA	287	39654	JABALOYAS	187	43217	BORDESLEY	169	49878	CARLTON 1	157
20663	MOUNA	260	39665	ALBARINO	46	43256	RAMPSTOW	168	49932	CARLTON 1	156
20709	MAURICIO	196	39668	ALBARINO	46	43261	DEMBLEBY	169	49935	CARLTON	156
20889	DODO	259	39671	BULCIAGO	43	43302	COMBWICH 1	153	49991	CARLTON 1	158
20897	ZIMBA	258	39672	BULCIAGO	43	43328	COTTINGHAM	166	49992	CARLTON 1	157
20913	CAVO	206	39673	BULCIAGO	44	43329	COTTINGHAM	166	49997	CARLTON 1	157
20917	GIRON	284	39674	BULCIAGO	45	43335	MARYSVILLE	168	62544	TORTORETO	174
20994	DOREEN	233	39754	SKOURA	63	43363	PADSTOW	165	62545	TORTORETO	174
32898	RIGA 5	254	39755	SKOURA	63	43364	PADSTOW	165	62559	TORTORETO	174
32899	RIGA 5	254	39756	SKOURA	64	43461	BASILDON	164	62561	TORTORETO	175
33682	LED CARPI	230	39757	SKOURA	64	43462	BASILDON	164	80265	MARS	281
35098	MARINELLA	10	39758	SKOURA	65	43464	BASILDON	164	80283	BARI	233
39117	FALCADO	146	39764	TAMARESCO	84	43606	HORNWOOD 2	160	82877	TWISTER	278
39126	MEDUNO	146	39773	TAMARESCO	85	43613	LACEY	201	82878	TWISTER	279
39133	BREA	195	39822	MENTALONA	73	43614	LACEY	201	82886	TWISTER	280
39134	BREA	195	39845	ESCUELA	82	43625	MILLIGAN	149	82887	TWISTER	281
39181	CAMPORALE	204	39865	GRANADILLOS	79	43626	MILLIGAN	149	82891	TWISTER	278
39232	CAMPORALE	204	39866	GRANADILLOS	80	43627	MILLIGAN	149	82893	TWISTER	280
39245	PIANOPOLI	18	39867	GRANADILLOS	80	43647	MILLIGAN	150	82941	PLANET	276
39246	PIANOPOLI	19	39882	TORTOLA	83	43649	MILLIGAN	150	82944	PLANET	276
39247	BREA	194	39915	LINDOZA	72	43651	MILLIGAN	150	82945	PLANET	276
39248	BREA	194	39918	SINSIGA	56	43782	EDALE	170	82946	PLANET 1	277
39344	CLIMENE	137	39921	SINSIGA	57	43783	EDALE	170	83153	PLANET 1	277
39462	VALPARAISO	26	39938	TOWNSHEND-B	87	43825	MATLOCK	159	83154	PLANET 1	277
39463	VALPARAISO	27	39938	SAVARNA	89	49039	CHESTER-P	208	83155	PLANET 1	274
39504	SIRACUSA	47	39952	ARENALES	58	49047	CHESTER-P	207	83156	PLANET 1	275
39509	SIRACUSA	144	39953	ARENALES	59	49038	CHESTER-P	207	83157	PLANET 1	274

# REGISTRO

## ARTICLE NUMBER

83158	PLANET 1	275	90049	AMADORA	287	94614	TABIANO	221	97606	CORTADERAS	107
83162	PLANET 1	274	90151	SCALEA 1	282	94615	TABIANO	221	97609	LORET TO	229
83163	PLANET 1	275	90166	BOND	259	94633	LASANA	176	97699	ALMONTE	228
83241	BORGO	284	90304	PINTO NERO	121	94634	LASANA	176	97739	CORETTO 4	142
84001	RIGA 1	256	90305	PINTO NERO	121	94651	ROMENDO	226	97745	MIRAFLORES	138
84002	RIGA 1	255	90695	DIAMOND	145	94652	ROMENDO	226	97754	COMPETA 1	230
84004	RIGA 1	256	90723	MAURICIO	196	94653	ROMENDO	227	97771	POLICARA	209
84026	GRAFIK	286	91046	FEDRA	145	94654	ROMENDO	226	97792	VALLASPRA	181
84028	GRAFIK	286	91168	CRATER	283	94742	CORETTO 2	155	97804	CORTADERAS	107
85262	RONDO	125	91236	MARS	281	94743	CORETTO 2	155	97887	PAUSIA	188
85263	RONDO	125	91808	MAGITA	282	94788	ALAMONTE 1	253	98017	GRADOLI	135
85337	MONO	232	91973	BAYMAN	123	94789	ALAMONTE 1	253	98023	MONTENOVO	268
85338	MONO	232	92562	BAYMAN	122	94863	MELGOA	250	98056	CORTENOVA	104
85339	MONO	232	92563	BAYMAN	122	94866	HILBURN 1	260	98057	CORTENOVA	105
85977	TROY 3	124	92564	BAYMAN	122	95005	NOVENTA	99	98058	CORTENOVA	104
85978	TROY 3	124	92751	SABBIO	283	95007	NOVENTA	99	98064	ADRI 3	186
85979	TROY 3	286	92781	CARDITO	118	95143	PALMERA 1	224	98065	CAMPODINO	205
85981	TROY 3	124	92782	CARDITO	118	95144	PALMERA 1	224	98065	ADRI 3	207
86873	TWISTER	278	92914	SABBIO 1	285	95216	PALTAS	138	98083	CORTENOVA	104
86875	TWISTER	280	93007	SABBIO 1	285	95555	BOLANOS	100	98087	CULPINA	243
86993	ARKTIC	258	93253	KIBEA	240	95557	BOLANOS	101	98088	CULPINA	243
88052	VENTO	258	93413	CALAONDA	22	95561	BOLANOS	100	98192	CAMARGO	140
88284	PALERMO	224	93423	CALAONDA	21	95562	BOLANOS	101	98273	ALAMONTE 1	253
88314	HALVA	116	93424	CALAONDA	21	95955	TORONJA	145	98291	TORRENTES	130
88315	HALVA	116	93425	CALAONDA	20	96194	SENDERO	137	98313	VARILLAS	143
88317	HALVA	116	93433	CALAONDA	23	96204	SANIA 3	185	98351	RAMON	143
88318	HALVA	117	93625	CARDITO 1	118	96299	LERIDA	178	98364	SABALETE	140
88562	HALVA	117	93653	GLENN	197	96331	NEVADO	139	98614	ALOBRASE	130
88563	HALVA	117	93654	GLENN	197	96566	TAZZOLI	183	98694	SELVINO	96
89246	MILLA 3	284	93662	PIANOPOLI	17	96567	TAZZOLI	183	98695	SELVINO	96
89324	TOLEDA	268	93693	PIERINO	193	97146	CALDIERO	247	98698	SELVINO	97
89543	ZIMBA LED	261	93909	FORNES	139	97285	SIRMIONE	251	98699	SELVINO	97
89544	ZIMBA LED	261	93927	FABIANA 1	120	97361	PALOZZA	103	98731	PRATA VECCHIA	251
89545	ZIMBA LED	262	93931	FABIANA 1	120	97362	PALOZZA	103	98755	ELIZONDO	187
89546	ZIMBA LED	262	93932	FABIANA 1	120	97363	PALOZZA	103	98836	ERMUA	136
89758	RAYA	283	93991	BOSARO	242	97429	FRISCOLI	229	99274	ESTEPERRA	81
90014	MALVA	273	94139	NOCELLA	246	97452	CALDIERO	247	99295	CAMACHO	202
90015	MALVA	273	94141	NOCELLA	246	97515	CHIETINO	205	99296	CAMACHO	202
90016	MALVA	273	94589	ROCAMAR	144	97531	BARI-M	231	99388	GRIMALDINO	180
90043	SCALEA 1	282	94613	TABIANO	221	97604	CORTADERAS	107	99408	BOYAL	112

# REGISTRO

ARTICLE NUMBER

99457	BOYAL	112	202638	DONINNI	245	204922	BOYAL	112	900347	NASTASIA	114
99614	OILELLA	94	203129	COMPETA 1	178	204986	CABEZOLA	34	900348	NASTASIA	114
99615	OILELLA	94	203386	GRADOLI	135	204987	CABEZOLA	35	900379	CONTRISA	141
99616	OILELLA	94	203454	PREDAZZO	241	204999	MARAGALL	52	900381	CONTRISA	141
99617	OILELLA	95	203455	PREDAZZO	241	205001	MARAGALL	51	900549	MARYVILLA	133
99633	MASETA	134	203617	TORTORETTO	106	205002	BERNABETA	36	900551	MARYVILLA	133
99634	MASETA	134	203618	TORTORETTO	106	205003	BERNABETA	37			
99651	LAGUNITAS	132	203649	TONARELLA	76	205004	MENTALONA	74			
99654	LAGUNITAS	132	203651	TONARELLA	77	205005	MENTALONA	75			
200022	ASCOLI 1	257	203784	ORMOND	182	205363	LIBERTAD	216			
200023	ASCOLI 1	257	203785	DAMBERA	182	205523	CAMACHO	217			
200032	RIGA 1	255	203795	GRADOLI	135	205524	ISIDRO	217			
200033	RIGA 1	255	203799	TORTORETTO	106	205525	PALMITAL	217			
200227	BAYMAN	123	203919	RIBAS	176	205619	COPLEY	214			
200228	BAYMAN	123	203921	MELDOLA	178	205621	TARBES	215			
200258	DEBED	142	204031	MARAGALL	50	205637	SKOURA	67			
200259	DEBED	142	204102	CANOPY	108	205643	ALTAMIRA	62			
200837	PARDELA	243	204103	CANOPY	108	205644	CERASELLA	131			
200886	KIBEA	240	204108	CANOPY	108	205646	LINDOZA	71			
201447	JUMILLA	192	204259	CARDITO	119	205653	PORTSEA	11			
201449	JUMILLA	192	204336	MAROJALES	181	390037	JAZMINIA	55			
201699	CARPI 1	179	204356	ANTELAO	31	390046	UPANEMA	88			
201701	CARPI 1	179	204357	ANTELAO	32	390066	DUGLIA	39			
201734	PIERINO	193	204358	ANTELAO	33	390067	DUGLIA	40			
201828	SANTANDER	209	204366	MONTEY	98	390089	CORDOBA	41			
202075	TABIANO	220	204368	GILWELL	110	390091	CORDOBA	42			
202125	MONTEY	98	204372	PALMERA 1	223	390176	PAZ	60			
202131	PEDREGAL	205	204373	PALMERA 1	223	390177	PAZ	60			
202308	EMBLETON	152	204374	PALMERA 1	222	390178	PAZ	61			
202339	BOLANOS	102	204375	PALMERA 1	222	900118	FANDINA	239			
202341	BOLANOS	102	204481	MADRONA	244	900119	FANDINA	239			
202363	MIERE	225	204482	MADRONA	244	900122	FOSSOMBRONE	264			
202364	MIERE	225	204485	MADRONA	218	900133	SERRICELLA	239			
202365	MIERE	225	204486	MADRONA	220	900136	ALAMONTE 3	252			
202423	GILWELL	110	204487	MADRONA	218	900139	ALAMONTE 3	252			
202633	SANIA 3	184	204488	MADRONA	220	900196	AGUILARES	131			
202634	SANIA 3	184	204544	BRANDEL	250	900259	LADUNARA	264			
202635	SANIA 3	185	204545	BRANDEL	250	900286	CARRARO	248			
202637	DONINNI	245	204558	ABNER	249	900289	BUDRONE	248			

# NOTES

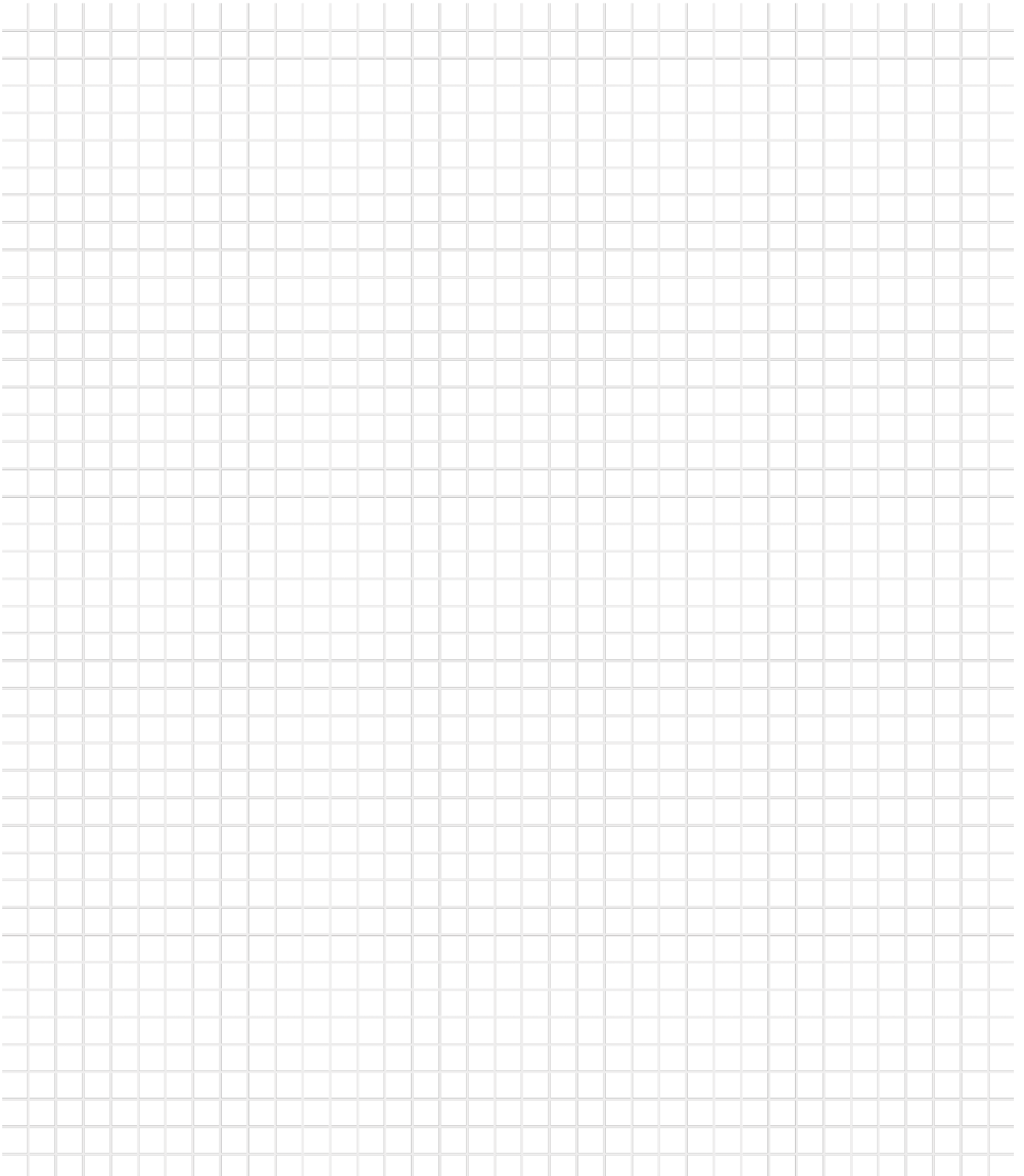

# NOTES

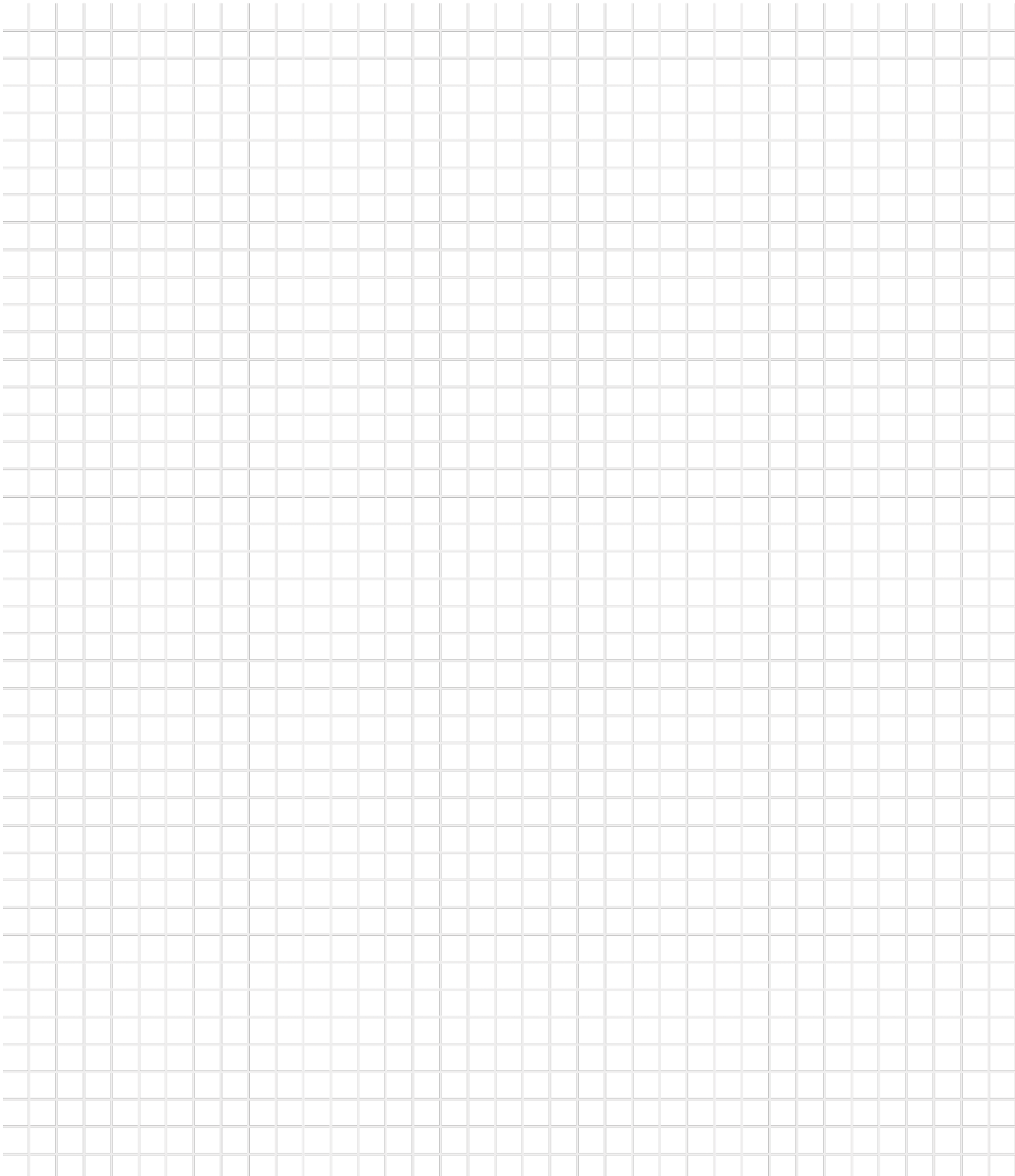



El catálogo anterior pierde su validez con la edición de éste nuevo catálogo. Nos reservamos los errores en modelo, impresión y modificaciones técnicas. La entrega del catálogo es en base a nuestras políticas. Productos con observaciones adicionales de seguridad (por ejemplo protección de clase, IP, etc) se identifican dentro de la familia de productos con el símbolo y el número correspondiente. El contenido de este catálogo está protegido por las leyes de derechos de autor para EGLO Leuchten GmbH. Todos los derechos reservados. Las imágenes de los productos y los ambientes de este catálogo pueden diferir de la realidad y no necesariamente el producto está aplicado de acuerdo a su uso habitual. EGLO no asume responsabilidad alguna por la exactitud o la representación de la aplicación de los productos y / o la información del mismo. Prohibida su reproducción sin previa autorización.

Diseño, maquetación y composición: EGLO MEXICO ILUMINACION S de RL de CV

Fotos: EGLO, Adobe Stock, istockphoto.com

Nuestros productos cumplen con la norma mexicana



*The previous catalog is no longer valid with the issue of this catalogue. Errors, misprints, model and price changes and technical modifications are reserved. We deliver based on our terms of delivery and payment. Products with additional safety remarks (e.g protection class, IP) are identified within the product family with the relevant symbol and number. The content of this catalogue is protected under copyright law for EGLO Leuchten GmbH. All rights reserved. The product pictures and ambiances in this catalogue can deviate from reality, and they do not necessarily concur with the usual application of the product. EGLO does not assume liability for the correctness, completeness or the application depiction of the products and/or the product information. Our specific written consent must be obtained before using any illustrations and texts.*

*Design, layout and composition: EGLO MEXICO ILUMINACION S de RL de CV  
Pictures: EGLO, Adobe Stock, istockphoto.com*

*Our products comply with the mexican light norm.*





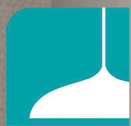

**EGLO**  
my light | my style

EGLO MÉXICO ILUMINACIÓN  
Prol. Av. Lopez Mateos Sur No. 3561  
Fracc. Los Gavilanes, C.P. 45645  
Tlajomulco de Zuñiga, Jalisco.  
Tel. 01 (33) 3687 2095 al 97  
E-Mail. [info-mexico@eglo.com](mailto:info-mexico@eglo.com)  
[www.eglo.com](http://www.eglo.com)

my light | my style

SHOWROOM PALMAS  
Paseo de las Palmas No. 270  
Col. Lomas de Chapultepec, C.P. 11000  
Delegación Miguel Hidalgo  
Ciudad de México.  
Móvil. 01 (33) 2530 4402  
E-Mail. [atencionalcliente5@eglo.com](mailto:atencionalcliente5@eglo.com)

SHOWROOM ALTAVISTA  
Magnolia No. 39, Planta Alta  
Col. Altavista, C.P. 0106  
Delegación Álvaro Obregón  
Ciudad de México.  
Tel. 55 9180 7610 01/ Móvil (33) 1000 1256  
E-Mail. [atencionalcliente4@eglo.com](mailto:atencionalcliente4@eglo.com)

